

# Product Catalog

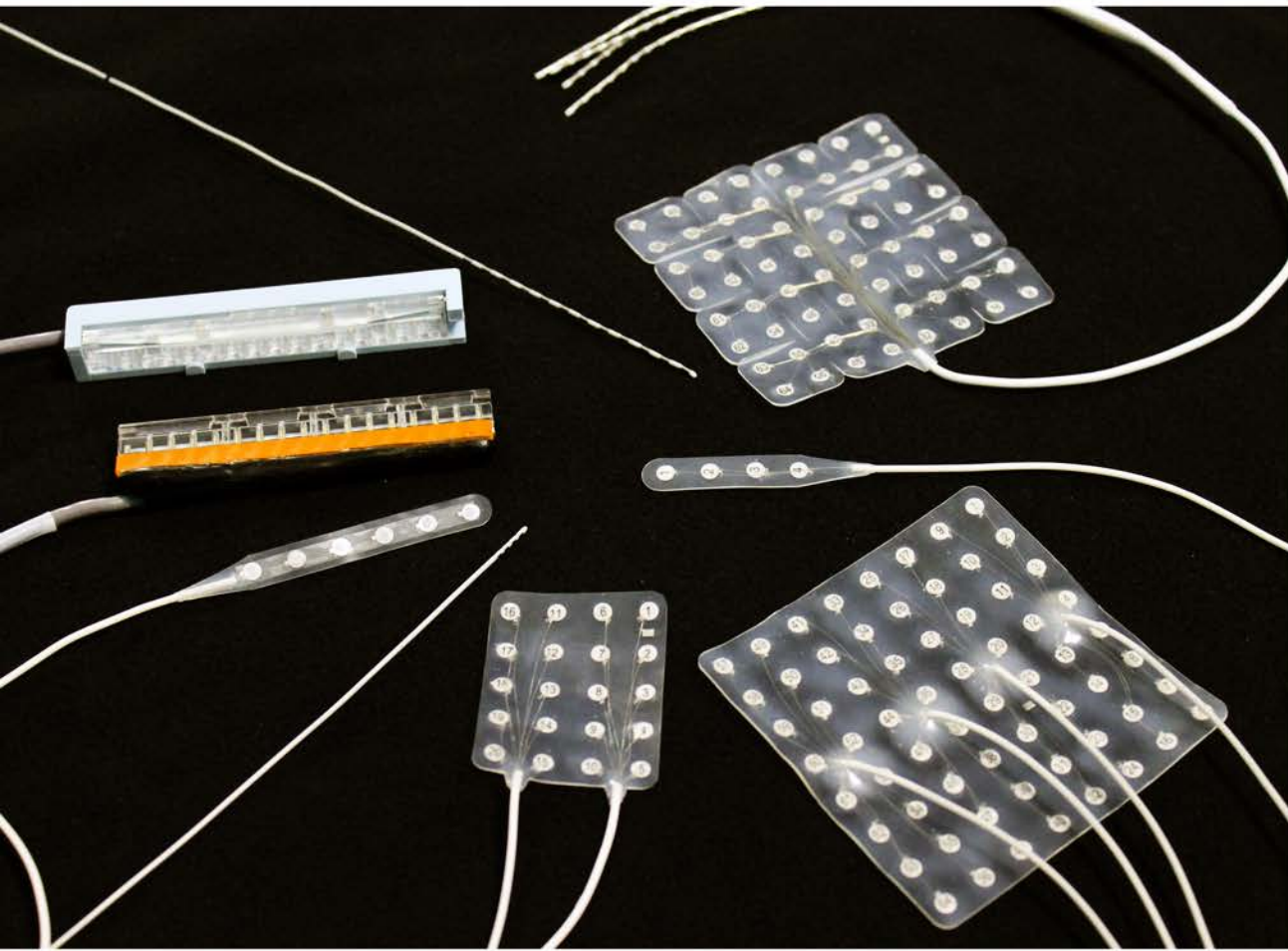

Volume VII

## WELCOME!

Welcome to Ad-Tech's catalog of products for the surgical treatment of epilepsy and for neurosurgery. We wish to thank you for your support and for choosing Ad-Tech.

## PURPOSE OF ELECTRODES

The Ad-Tech subdural, depth, and sphenoidal electrodes are intended for temporary (<30 days) use with recording, monitoring and stimulation equipment, for the recording, monitoring, and stimulation of electrical signals of the brain. The recording of electrical activity supports definition of the location of epileptogenic foci and brain mapping.



**AD-TECH<sup>®</sup>** MEDICAL INSTRUMENT CORPORATION

1901 WILLIAM STREET, RACINE, WI 53404 U.S.A.

Phone: 262-634-1555      Email: [sales@adtechmedical.com](mailto:sales@adtechmedical.com)

Fax: 262-634-5668      Website: [www.adtechmedical.com](http://www.adtechmedical.com)

**Toll Free: 800-776-1555**

# TABLE OF CONTENTS

	PAGE
<b>FREQUENTLY ORDERED ITEMS</b> .....	<b>4</b>
<b>SUBDURAL ELECTRODES</b>	
Subdural Strip Electrodes.....	5
Narrow-Body Subdural Strip Electrodes.....	6
IOM Subdural Strip Electrodes.....	7
“L” & “T” Shaped Subdural Strip & Grid Electrodes.....	8
“3D” Style Subdural Strip Electrodes.....	9
Contoured Subdural Grid Electrodes.....	10
Subdural Grid Electrodes.....	11-12
Perpendicular-Tail Subdural Grid Electrodes.....	13
Temporal Lobe Subdural Grid Electrodes.....	14
Single-Tail Subdural Grid Electrodes.....	15
Multi-Strip & Split-Grid Subdural Electrodes.....	16
Dual-Sided Interhemispheric Subdural Electrodes.....	17
<b>INTRAOPERATIVE MONITORING (IOM)</b>	
IOM Electrodes with Attached Cables.....	18
IOM Mapping Electrode System.....	19
Epidural Spinal Electrodes.....	19
<b>DEPTH ELECTRODES</b>	
Spencer® Probe Depth Electrodes.....	20-21
Behnke Fried Depth Electrodes.....	22
Macro-Micro Depth Electrodes.....	23
Foramen Ovale Electrodes.....	24
<b>PLACEMENT ACCESSORIES</b>	
Depth Electrode Anchor Bolts.....	24
Depth Electrode Placement Accessories.....	25-28
Disposable Drill Kits.....	29
Passing Needles.....	29
<b>CONNECTION SYSTEMS</b>	
Lightweight Electrode Connection Systems.....	30
Lightweight Quick Disconnect Cables.....	31
Disposable Connector Blocks.....	31
<b>MISCELLANEOUS PRODUCTS</b>	
Disposable Brain Biopsy Needles.....	32
Cueva Intraoperative Cranial Nerve Electrodes.....	33
Subpial Transectors.....	34
Sphenoidal Electrodes.....	34



# AD-TECH® FREQUENTLY ORDERED PRODUCTS

FREQUENTLY ORDERED PRODUCTS

## Strip Electrodes

**Catalog #: TS04R-SP10X-000**

4-contact, 1x4 LTM strip. Non-numbered. with reinforcement. Platinum, 10 mm spacing.

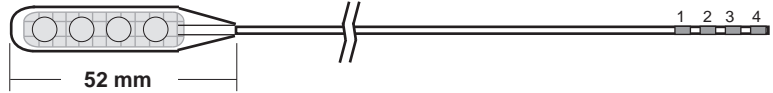

**Catalog #: IS04R-SP10X-000**

4-contact, 1x4 IOM strip. Numbered. Platinum, 10 mm spacing.

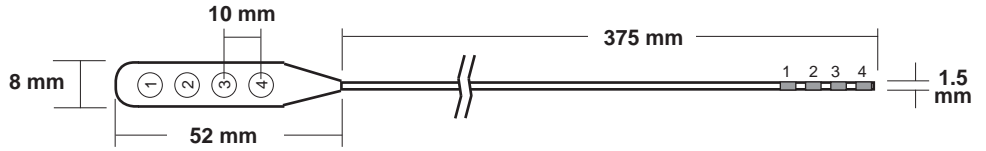

## Grid Electrodes

**Catalog #: FG20C-SP10X-000**

20-contact, 4x5 LTM grid, 2 tails. Platinum, 10 mm spacing.

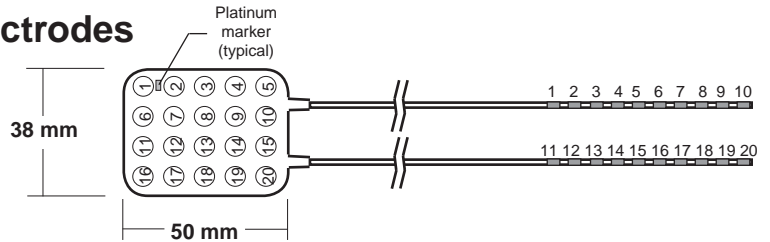

**Catalog #: FG64C-SP10X-0C6**

64-contact, 8x8 LTM grid, 4 tails. Platinum, 10 mm spacing, Scallops & slits.

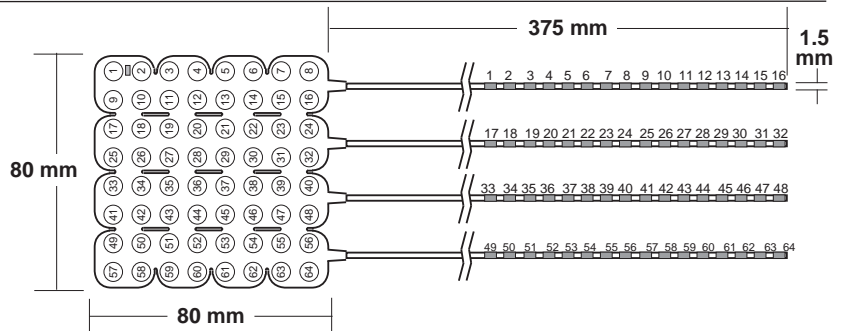

## IOM Electrodes with Cables Attached

**Catalog #: MS04R-IP10X-0JH**

4-contact, 1x4 IOM strip, 6mm contacts. Platinum, 10 mm spacing. Attached 1.8m cable

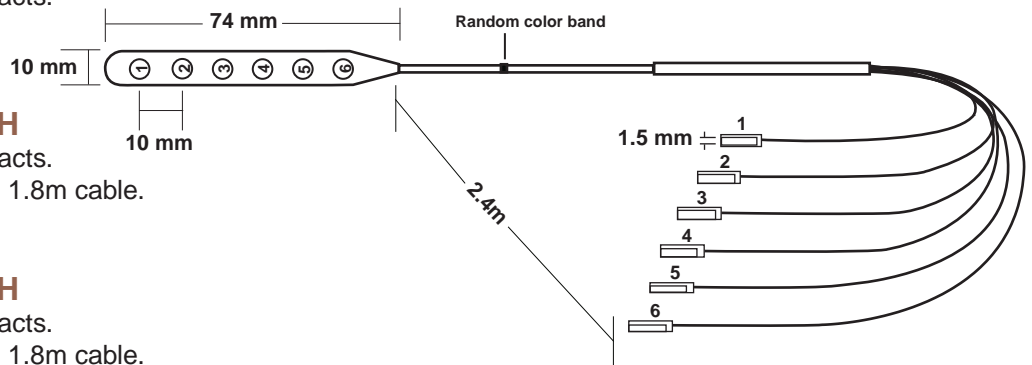

**Catalog #: MS06R-IP10X-0JH**

6-contact, 1x6 IOM strip, 6mm contacts. Platinum, 10 mm spacing. Attached 1.8m cable.

*Pictured to the right.*

**Catalog #: MS08R-IP10X-0JH**

8-contact, 1x8 IOM strip, 6mm contacts. Platinum, 10 mm spacing. Attached 1.8m cable.

## Depth Electrodes

**Catalog #: SD04R-SP05X-000**

4-contact depth, 5mm spacing. *Pictured to the right.*

**Catalog #: SD06R-SP05X-000**

6-contact depth, 5mm spacing.

**Catalog #: SD08R-SP05X-000**

8-contact depth, 5mm spacing.



# AD-TECH® EPILEPSY/LTM SUBDURAL STRIP ELECTRODES

- 8mm width.
- Thin and flexible.
- **Platinum** or **stainless steel** contacts, 4.0mm diameter with 2.3mm exposure.
- Non-numbered with reinforcement, designed for long-term monitoring applications.
- Sterile; single-use only.

**Catalog #: TS02R-SP10X-000**  
**& TS02R-SS10X-000**

2-contact, 1x2 LTM strip. 10mm spacing.

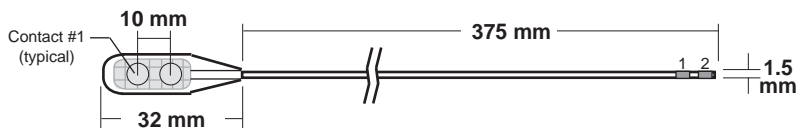

**Catalog #: TS04R-SP10X-000**  
**& TS04R-SS10X-000**

4-contact, 1x4 LTM strip. 10mm spacing.

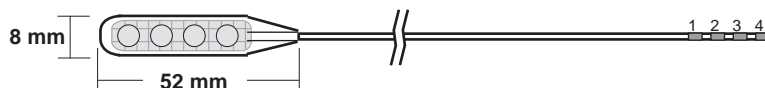

**Catalog #: TS04R-SP15X-000**  
**& TS04R-SS15X-000**

4-contact, 1x4 LTM strip. 15mm spacing.

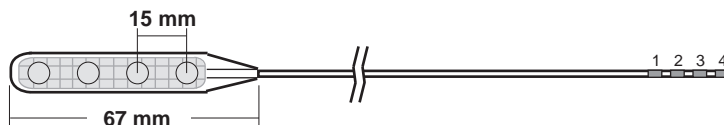

**Catalog #: TS06R-SP10X-000**  
**& TS06R-SS10X-000**

6-contact, 1x6 LTM strip. 10mm spacing.

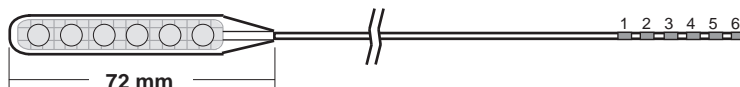

**Catalog #: TS08R-SP10X-000**  
**& TS08R-SS10X-000**

8-contact, 1x8 LTM strip. 10mm spacing.

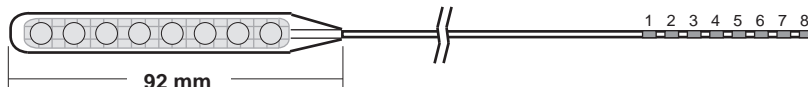

**Catalog #: TS10R-SP10X-000**  
**& TS10R-SS10X-000**

10-contact, 1x10 LTM strip. 10mm spacing.

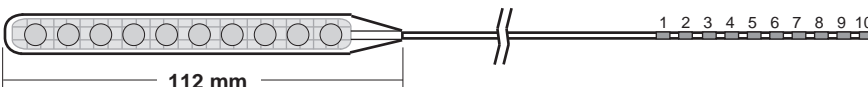

**Catalog #: TS12R-SP10X-000**  
**& TS12R-SS10X-000**

12-contact, 1x12 LTM strip. 10mm spacing.

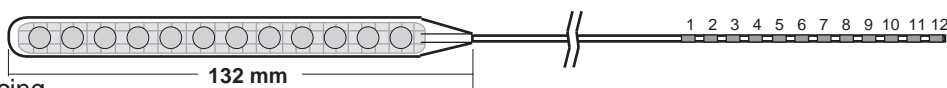

Electrodes are shown with the exposed contact surfaces facing DOWN.

Platinum	Catalog #		Description	CABRIO Cable	TECH-ATTACH Components		
	Platinum	Stainless Steel			Cable	Block	Qty
	<b>TS02R-SP10X-000</b>	<b>TS02R-SS10X-000</b>	1x2 LTM strip	L-SRL-2DIN	L-DC-2DIN	DC-2X	1
	<b>TS04R-SP10X-000</b>	<b>TS04R-SS10X-000</b>	1x4 LTM strip	L-SRL-4DIN	L-DCL-4DIN	DC-4X	1
	<b>TS04R-SP15X-000</b>	<b>TS04R-SS15X-000</b>	1x4 LTM strip	L-SRL-4DIN	L-DCL-4DIN	DC-4X	1
	<b>TS06R-SP10X-000</b>	<b>TS06R-SS10X-000</b>	1x6 LTM strip	L-SRL-6DIN	L-DCL-6DIN	DC-6X	1
	<b>TS08R-SP10X-000</b>	<b>TS08R-SS10X-000</b>	1x8 LTM strip	L-SRL-8DIN	L-DCL-8DIN	DC-8X	1
	<b>TS10R-SP10X-000</b>	<b>TS10R-SS10X-000</b>	1x10 LTM strip	L-SRL-10DIN	L-DCL-10DIN	DC-10X	1
	<b>TS12R-SP10X-000</b>	<b>TS12R-SS10X-000</b>	1x12 LTM strip	L-SRL-12BDIN	L-DCL-12BDIN	DC-12X	1

# AD-TECH® EPILEPSY/LTM NARROW-BODY SUBDURAL STRIP ELECTRODES

- 4.0mm contact diameter with reduced contact exposure (1.8mm).
- Non-numbered with reinforcement, designed for long-term monitoring applications.
- **Platinum** contacts.
- Thin and flexible.
- 6mm width.
- Sterile; single-use only.

SUBDURAL ELECTRODES - STRIP

**Catalog #: TS04R-AP10X-0W6**  
4-contact, 1x4 narrow-body LTM strip.  
Platinum contacts, 10mm spacing.

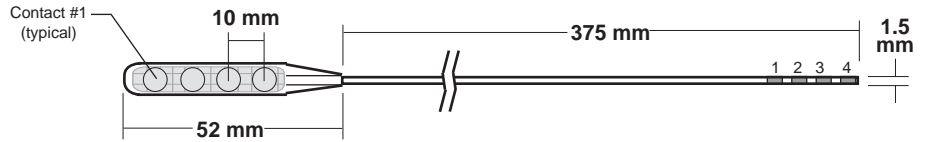

**Catalog #: TS06R-AP10X-0W6**  
6-contact, 1x6 narrow-body LTM strip.  
Platinum contacts, 10mm spacing.

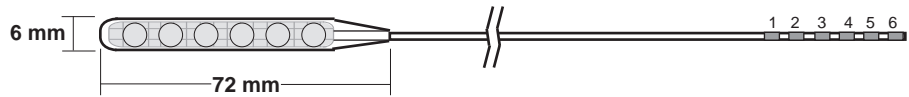

**Catalog #: TS08R-AP10X-0W6**  
8-contact, 1x8 narrow-body LTM strip.  
Platinum contacts, 10mm spacing.

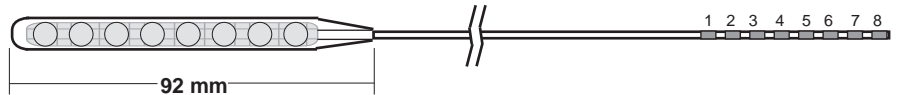

Electrodes are shown with the exposed contact surfaces facing DOWN.

Catalog #	Description	CABRIO Cable	TECH-ATTACH Components		
			Cable	Block	Qty
TS04R-AP10X-0W6	1x4 narrow-body strip	L-SRL-4DIN	L-DCL-4DIN	DC-4X	1
TS06R-AP10X-0W6	1x6 narrow-body strip	L-SRL-6DIN	L-DCL-6DIN	DC-6X	1
TS08R-AP10X-0W6	1x8 narrow-body strip	L-SRL-8DIN	L-DCL-8DIN	DC-8X	1

# AD-TECH® INTRAOPERATIVE MONITORING SUBDURAL STRIP ELECTRODES

- Intraoperative monitoring electrodes feature numbered contacts, greater visibility of the recording surface, and greater flexibility of the electrode contact area.
- **Platinum** or **stainless steel** numbered contacts, 4.0mm diameter with 2.3mm exposure.
- Sterile; single-use only.

## Catalog #: **IS04R-SP10X-000** & **IS04R-SS10X-000**

4-contact, 1x4 IOM strip.

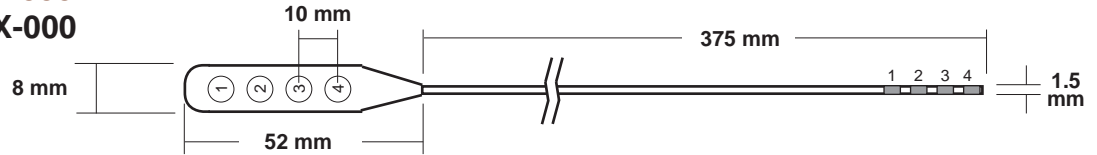

## Catalog #: **IS06R-SP10X-000** & **IS06R-SS10X-000**

6-contact, 1x6 IOM strip.

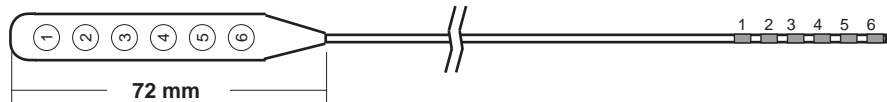

## Catalog #: **IS08R-SP10X-000** & **IS08R-SS10X-000**

8-contact, 1x8 IOM strip.

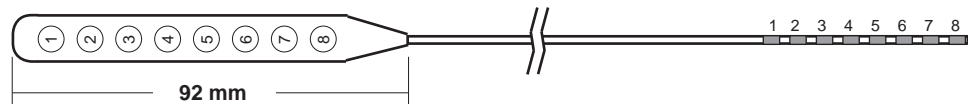

Electrodes are shown with the exposed contact surfaces facing DOWN.

Platinum	Catalog #		Description	CABRIO Cable	TECH-ATTACH Components		
	Stainless Steel				Cable	Block	Qty
<b>IS04R-SP10X-000</b>	<b>IS04R-SS10X-000</b>		1x4 IOM strip	L-SRL-4DIN	L-DCL-4DIN	DC-4X	1
<b>IS06R-SP10X-000</b>	<b>IS06R-SS10X-000</b>		1x6 IOM strip	L-SRL-6DIN	L-DCL-6DIN	DC-6X	1
<b>IS08R-SP10X-000</b>	<b>IS08R-SS10X-000</b>		1x8 IOM strip	L-SRL-8DIN	L-DCL-8DIN	DC-8X	1

# AD-TECH® EPILEPSY/LTM “L” & “T” SHAPED SUBDURAL STRIP & GRID ELECTRODES

- Numbered, **platinum** contacts with platinum markers as shown, 4.0mm diameter with 2.3mm exposure.
- “L” and “T” shapes offer you different tail-exit options
- 37.5cm tail length.
- Sterile; single-use only.

**Catalog #: MS08L-SP10X-A00**

8-contact, reversed “L” shaped LTM strip.  
Platinum contacts, 10mm spacing.

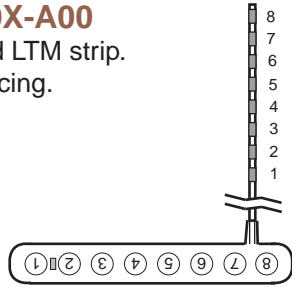

**Catalog #: MS08I-SP10X-B00**

8-contact, “L” shaped LTM strip.  
Platinum contacts, 10mm spacing.

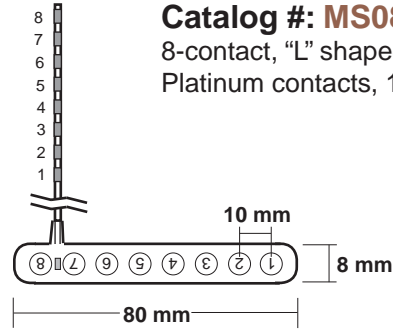

**Catalog #: MS08L-SP10X-E00**

8-contact, curved reversed “L” shaped LTM strip.  
LTM strip. Platinum contacts, 10mm spacing.

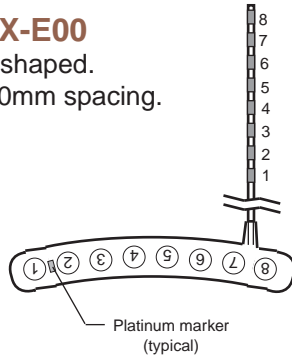

**Catalog #: MS08I-SP10X-F00**

8-contact, curved “L” shaped LTM strip.  
Platinum contacts, 10mm spacing.

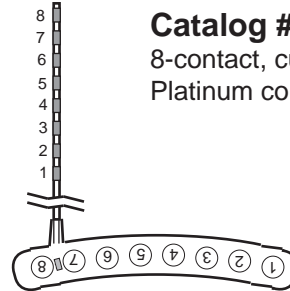

**Catalog #: MS08R-SP10X-C00**

8-contact, “T” shaped LTM strip.  
Platinum contacts, 10mm spacing.

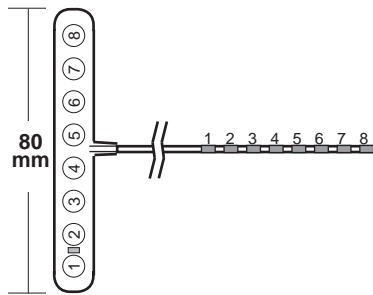

Electrodes are shown with the exposed contact surfaces facing DOWN.

Catalog #	Description	CABRIO Cable	TECH-ATTACH Components		
			Cable	Block	Qty
MS08L-SP10X-A00	Reversed “L” shaped LTM strip	L-SRL-8DIN	L-DCL-8DIN	DC-8X	1
MS08I-SP10X-B00	“L” shaped LTM strip	L-SRL-8DIN	L-DCL-8DIN	DC-8X	1
MS08L-SP10X-E00	Curved, reversed “L” LTM strip	L-SRL-8DIN	L-DCL-8DIN	DC-8X	1
MS08I-SP10X-F00	Curved “L” shaped LTM strip	L-SRL-8DIN	L-DCL-8DIN	DC-8X	1
MS08R-SP10X-C00	“T” shaped LTM strip	L-SRL-8DIN	L-DCL-8DIN	DC-8X	1

SUBDURAL ELECTRODES - STRIP



# AD-TECH® EPILEPSY/LTM “3D” STYLE SUBDURAL STRIP ELECTRODES

- Large, indented 6.0mm diameter contacts with 5.0mm diameter exposed recording area.
- Numbered, **platinum** contacts.
- 10mm contact spacing.



Cross-section view of 3D style contact

## Catalog #: MS04R-IP10X-000

4-contact, 1x4 “3D” style strip.  
Platinum contacts.

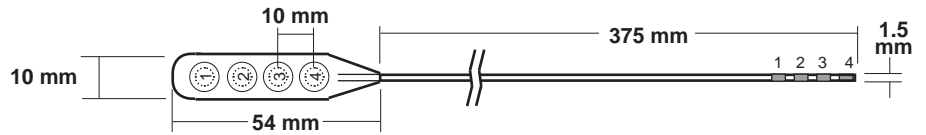

## Catalog #: MS06R-IP10X-000

6-contact, 1x6 “3D” style strip.  
Platinum contacts.

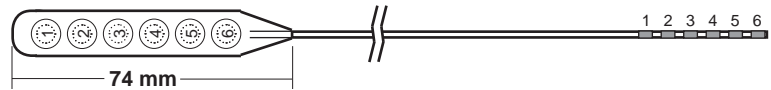

## Catalog #: MS08R-IP10X-000

8-contact, 1x8 “3D” style strip.  
Platinum contacts.

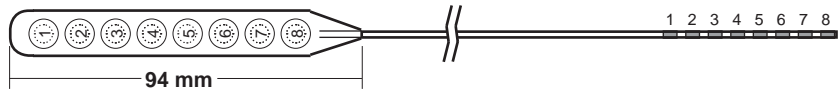

Electrodes are shown with the exposed contact surfaces facing DOWN.

Catalog #	Description	CABRIO Cable	TECH-ATTACH Components		
			Cable	Block	Qty
MS04R-IP10X-000	1x4 large, “3D” style platinum strip	L-SRL-4DIN	L-DCL-4DIN	DC-4X	1
MS06R-IP10X-000	1x6 large, “3D” style platinum strip	L-SRL-6DIN	L-DCL-6DIN	DC-6X	1
MS08R-IP10X-000	1x8 large, “3D” style platinum strip	L-SRL-8DIN	L-DCL-8DIN	DC-8X	1

# AD-TECH® EPILEPSY/LTM CONTOURED SUBDURAL GRID ELECTRODES

- Contoured shape may provide more flexibility to conform to the brain. Contact Ad-Tech to inquire if your preferred grid can also be contoured.
- Numbered, **platinum** contacts, 4.0mm diameter with a 2.3mm exposure.
- May be used with the single-tail passing needles.
- 10mm contact spacing is standard; additional spacing options available.
- Sterile; single-use only.

**Catalog #: FG64C-SP10X-0C6**  
64-contact, 8x8, 4 tail LTM contoured grid.  
Platinum contacts.

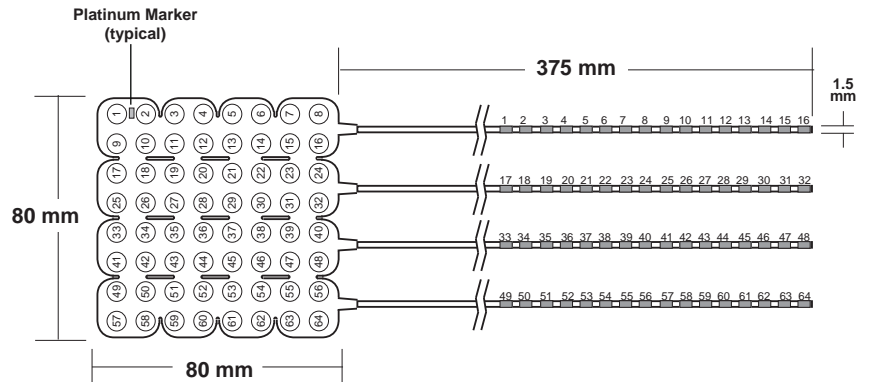

**Catalog #: FG64C-SP10X-0CB**  
64-contact, 8x8, single-tail LTM contoured grid.  
Platinum contacts.

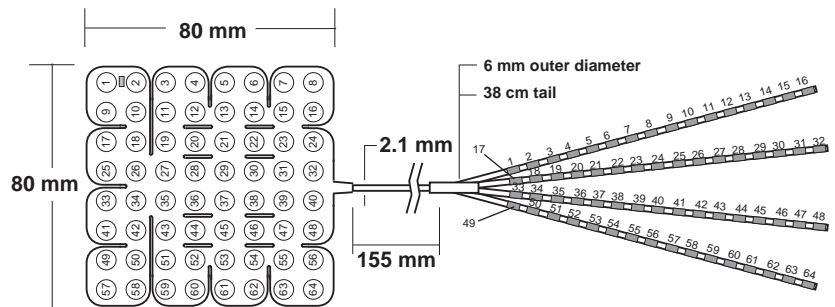

Electrodes are shown with the exposed contact surfaces facing DOWN.

Catalog #	Description	CABRIO Cable	TECH-ATTACH Components		
			Cable	Block	Qty
<b>FG64C-SP10X-0C6</b>	8x8, 4-tail LTM contoured grid	L-SRL-64BDIN	L-DCL-64BDIN	DC-16X	4
<b>FG64C-SP10X-0CB</b>	8x8, single-tail LTM contoured grid	L-SRL-64BDIN	L-DCL-64BDIN	DC-16X	4

# AD-TECH® EPILEPSY/LTM SUBDURAL GRID ELECTRODES

- Epilepsy/LTM subdural electrodes are for monitoring/mapping the cortical surface for the surgical treatment of epilepsy.
- Numbered, **platinum** or **stainless steel** contacts, 4.0mm diameter with 2.3mm exposure, 10mm contact spacing (unless otherwise noted).
- Sterile; single-use only.
- Most electrodes can be manufactured contoured and slit upon request.

## Catalog #: FG08A-SP10X-000

8-contact, 2x4, single-tail LTM grid.

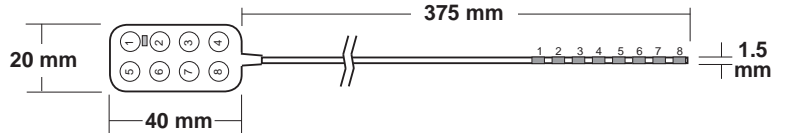

## Catalog #: FG16A-SP10X-000 & FG16A-SS10X-000

16-contact, 2x8, single-tail LTM grid.

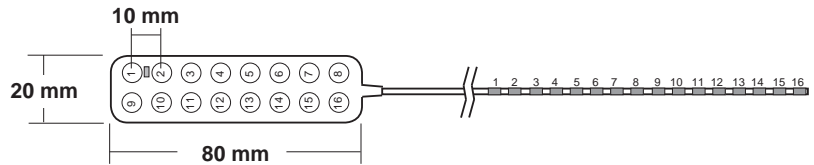

## Catalog #: FG20C-SP10X-000 & FG20C-SS10X-000

20-contact, 4x5, 2-tail LTM grid.

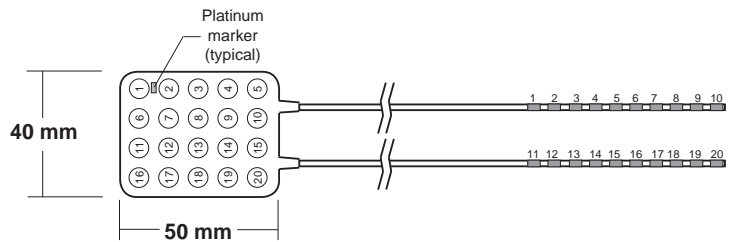

## Catalog #: FG32C-SP10X-000 & FG32C-SS10X-000

32-contact, 4x8, 2-tail LTM grid.

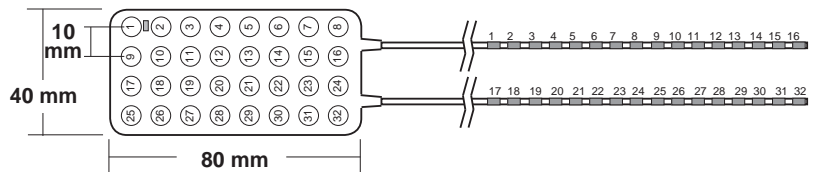

Electrodes are shown with the exposed contact surfaces facing DOWN.

Catalog #	Description		CABRIO Cable	TECH-ATTACH Components			
	Platinum	Stainless Steel		Cable	Block	Qty	
FG08A-SP10X-000		N/A	2x4, single-tail LTM grid	L-SRL-8DIN	L-DCL-8DIN	DC-8X	1
FG16A-SP10X-000		FG16A-SS10X-000	2x8, single-tail LTM grid	L-SRL-16BDIN	L-DCL-16BDIN	DC-16X	1
FG20C-SP10X-000		FG20C-SS10X-000	4x5, 2-tail LTM grid	L-SRL-20DIN	L-DCL-20DIN	DC-10X	2
FG32C-SP10X-000		FG32C-SS10X-000	4x8, 2-tail LTM grid	L-SRL-32BDIN	L-DCL-32BDIN	DC-16X	2



# AD-TECH® EPILEPSY/LTM SUBDURAL GRID ELECTRODES (CONTINUED)

**Catalog #: FG48G-SP10X-000  
& FG48G-SS10X-000**

48-contact, 6x8, 3-tails LTM grid.  
10mm contact spacing.

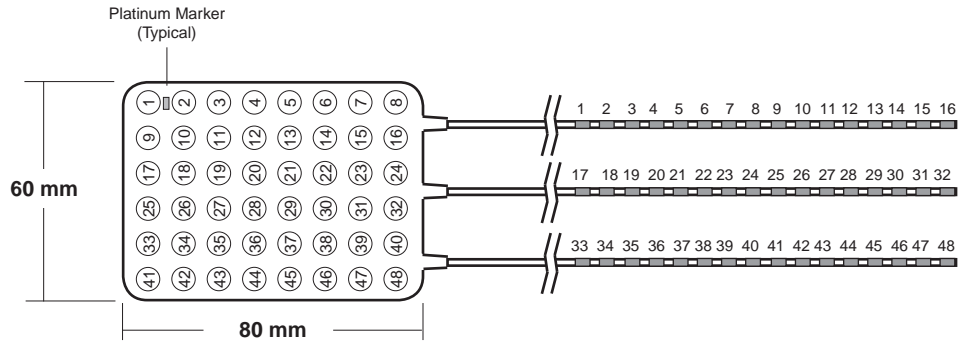

**Catalog #: FG64C-SP10X-000  
& FG64C-SS10X-000**

64-contact, 8x8, 4-tails LTM grid.  
10mm contact spacing.

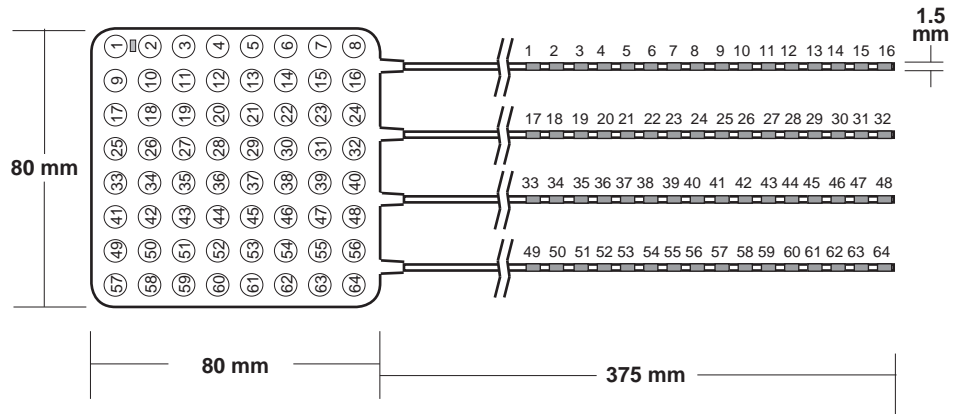

**Catalog #: FG64C-SP05X-000  
& FG64C-SS05X-000**

64-contact, 8x8, 4-tails LTM grid.  
5mm contact spacing.

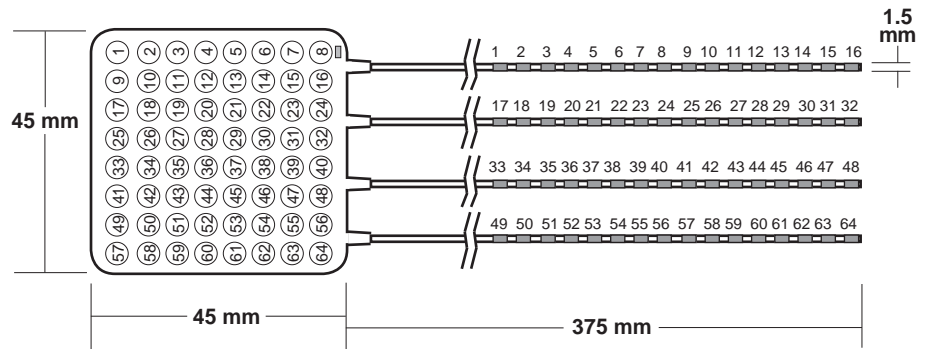

Electrodes are shown with the exposed contact surfaces facing DOWN.

SUBDURAL ELECTRODES - GRID

Catalog #		Description	CABRIO Cable	TECH-ATTACH Components		
Platinum	Stainless Steel			Cable	Block	Qty
FG48G-SP10X-000	FG48G-SS10X-000	6x3, 3-tail LTM grid	L-SRL-48BDIN	L-DCL-48BDIN	DC-16X	3
FG64C-SP10X-000	FG64C-SS10X-000	8x8, 4-tail LTM grid	L-SRL-64BDIN	L-DCL-64BDIN	DC-16X	4
FG64C-SP05X-000	FG64C-SS05X-000	8x8, 4-tail LTM grid	L-SRL-64BDIN	L-DCL-64BDIN	DC-16X	4

# AD-TECH® EPILEPSY/LTM PERPENDICULAR-TAIL SUBDURAL GRID ELECTRODES

- Perpendicular tail design may allow for a smaller craniotomy.
- Numbered, **platinum** contacts, 4.0mm contacts with 2.3mm exposure.
- Sterile; single-use only.
- Contoured and slit.

## Catalog #: FG64C-SP10X-020

64-contact, 8x8, 4-tails 90° from center,  
Tails positioned closer together. LTM grid.  
Platinum contacts.

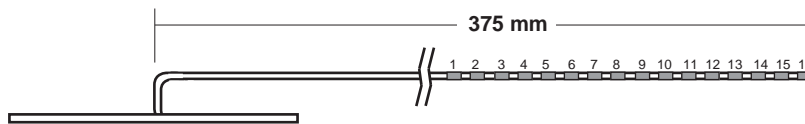
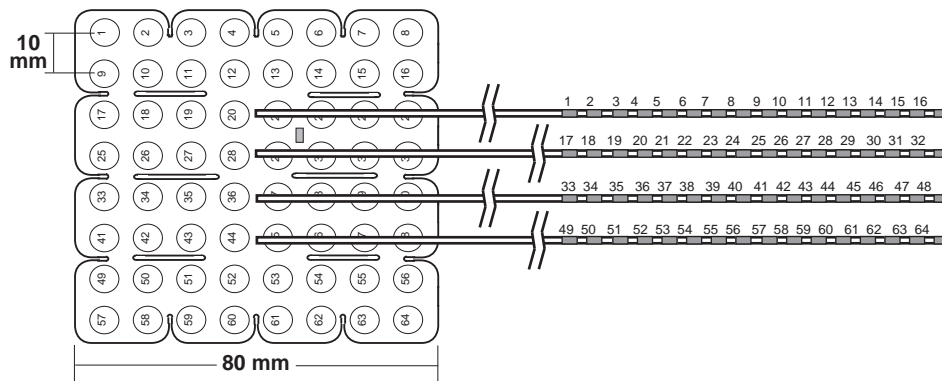

Side view of FG64C-SP10X-020

Electrodes are shown with the exposed contact surfaces facing DOWN.

Catalog #	Description	CABRIO Cable	TECH-ATTACH Components		
			Cable	Block	Qty
FG64C-SP10X-020	8x8, 4-tail 90°-center LTM grid	L-SRL-64BDIN	L-DCL-64BDIN	DC-16X	4

# AD-TECH® EPILEPSY/LTM TEMPORAL LOBE SUBDURAL GRID ELECTRODES

- Right and left temporal lobe electrodes are designed for the temporal and sub-temporal cortex.
- Numbered, **platinum** contacts, 4.0mm diameter with 2.3mm exposure.
- Sterile; single-use only.

## Catalog #: FG35D-SP10X-Z00

35-contact right temporal lobe LTM grid.  
Platinum contacts.

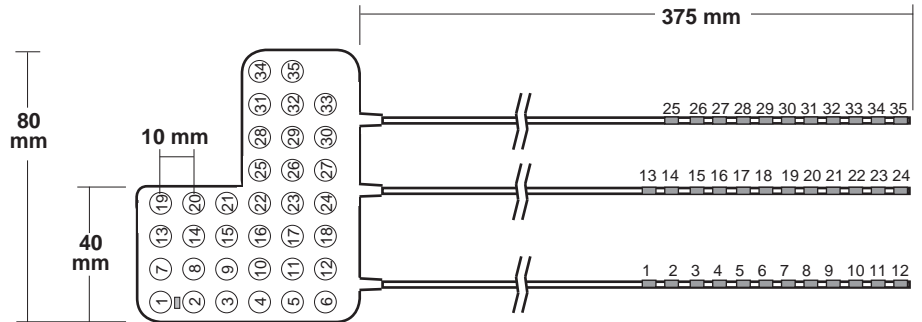

## Catalog #: FG35E-SP10X-Z00

35-contact left temporal lobe LTM grid.  
Platinum contacts.

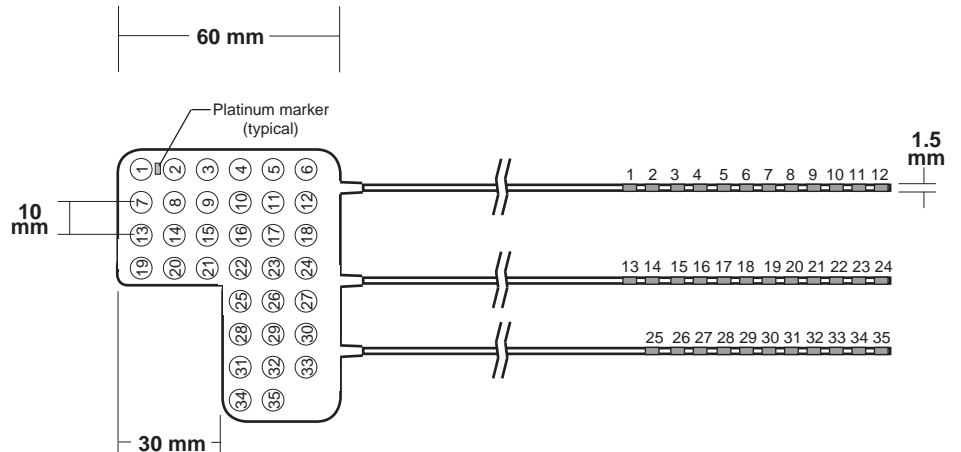

Electrodes are shown with the exposed contact surfaces facing DOWN.

Catalog #	Description	CABRIO Cable	TECH-ATTACH Components		
			Cable	Block	Qty
FG35D-SP10X-Z00	Right temporal lobe LTM grid	L-SRL-35DIN	L-DCL-35DIN	DC-11X & DC-12X	1 2
FG35E-SP10X-Z00	Left temporal lobe LTM grid	L-SRL-35DIN	L-DCL-35DIN	DC-11X & DC-12X	1 2



# AD-TECH® EPILEPSY/LTM SINGLE-TAIL SUBDURAL GRID ELECTRODES

- Numbered, **platinum** contacts, 4.0mm diameter with 2.3mm exposure.
- May be used with the single-tail passing needles.
- Single-tail construction reduces the number of tunnels.
- 60cm long tail.
- Sterile; single-use only.

## Catalog #: IG20C-SP10X-0TB

20-contact, 4x5, single-tail LTM grid.  
Platinum contacts.

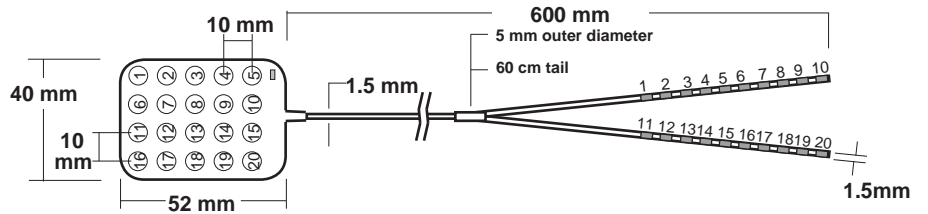

## Catalog #: IG32C-SP10X-0TB

32-contact, 4x8, single-tail LTM grid.  
Platinum contacts.

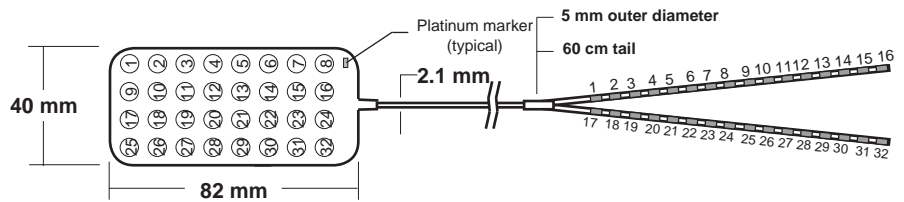

## Catalog #: IG64C-SP10X-0TB

64-contact, 8x8, single-tail LTM grid.  
Platinum contacts.

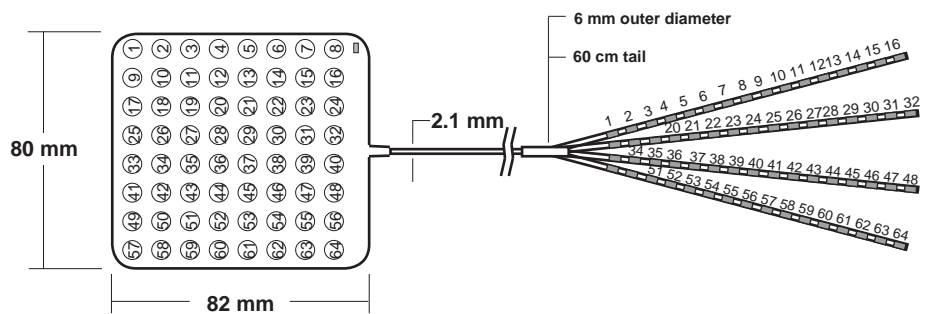

Electrodes are shown with the exposed contact surfaces facing DOWN.

Catalog #	Description	CABRIO Cable	TECH-ATTACH Components		
			Cable	Block	Qty
IG20C-SP10X-0TB	4x5 LTM grid	L-SRL-20DIN	L-DCL-20DIN	DC-10X	2
IG32C-SP10X-0TB	4x8 LTM grid	L-SRL-32BDIN	L-DCL-32BDIN	DC-16X	2
IG64C-SP10X-0TB	8x8 LTM grid	L-SRL-64BDIN	L-DCL-64BDIN	DC-16X	4

# AD-TECH® EPILEPSY/LTM MULTI-STRIP & SPLIT-GRID SUBDURAL ELECTRODES

SUBDURAL ELECTRODES

- Markers as shown for easy identification.
- Sterile; single-use only.
- **Platinum** contacts, 4.0mm diameter with 2.3mm exposure.
- Multi-strip and split-grid construction reduces the number of tunnels.
- May be used with the single-tail passing needles.

## Catalog #: GG16A-SP10X-100

16-contact, 4x1x4, 2-tail.  
Multi-strip LTM subdural electrode.  
Platinum contacts.  
41cm tail length.

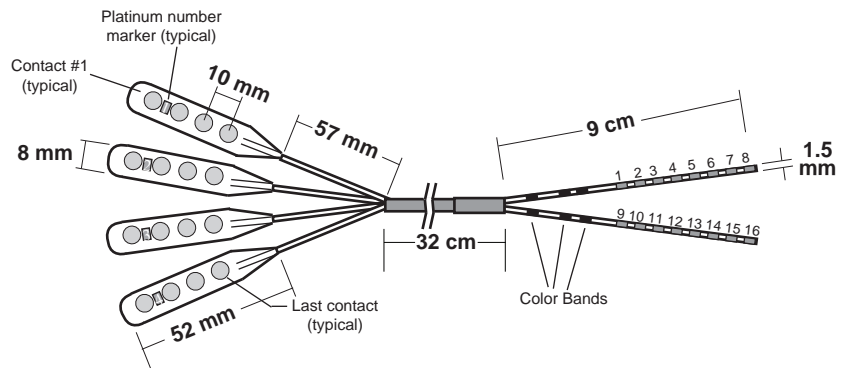

## Catalog #: HG32A-SP05X-000

32-contact, 2x2x8, 2-tail.  
Split-grid LTM subdural grid electrode.  
Platinum contacts.  
57cm tail length.

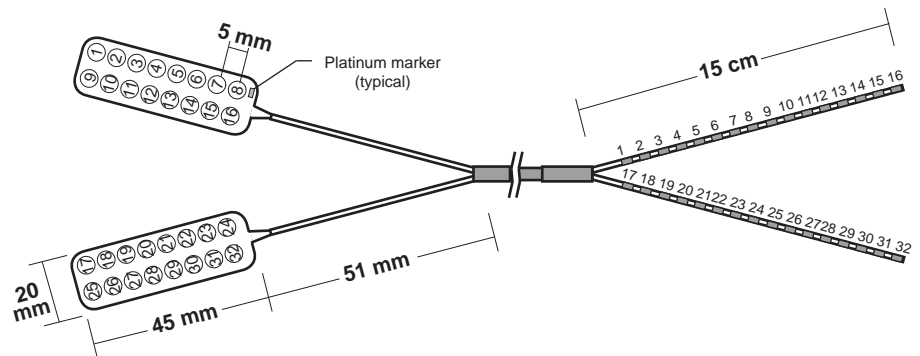

Electrodes are shown with the exposed contact surfaces facing DOWN.

Catalog #	Description	CABRIO Cable	TECH-ATTACH Components		
			Cable	Block	Qty
GG16A-SP10X-100	4x1x4, 2-tail multi-strip	L-SRL-16DIN	L-DCL-16DIN	DC-8X	2
HG32A-SP05X-000	2x2x8, 2-tail split-grid	L-SRL-32BDIN	L-DCL-32BDIN	DC-16X	2



# AD-TECH® EPILEPSY/LTM DUAL-SIDED INTERHEMISPHERIC SUBDURAL ELECTRODES

- Mirror-imaged contacts on both sides of the electrode.
- Platinum & number markers as shown.
- Sterile; single-use only.
- **Platinum** contacts, 4.0mm diameter with 2.3mm exposure.

## Catalog #: DS08A-SP10X-000

8-contact, 1x4, dual-sided LTM strip.  
Platinum contacts.

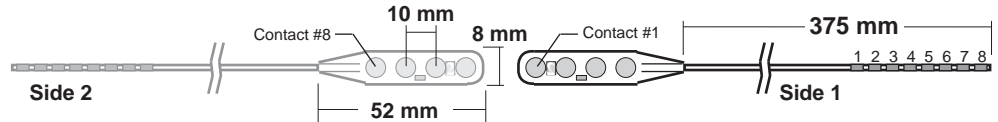

## Catalog #: DS12A-SP10X-000

12-contact, 1x6, dual-sided LTM strip.  
Platinum contacts.

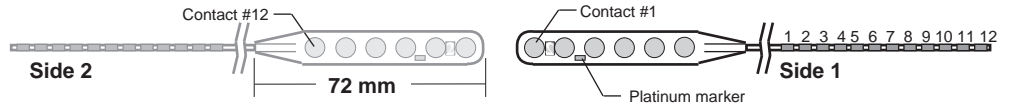

## Catalog #: DG20A-SP10X-U00

20-contact, 2x5, angled, dual-sided LTM grid.  
Platinum contacts.

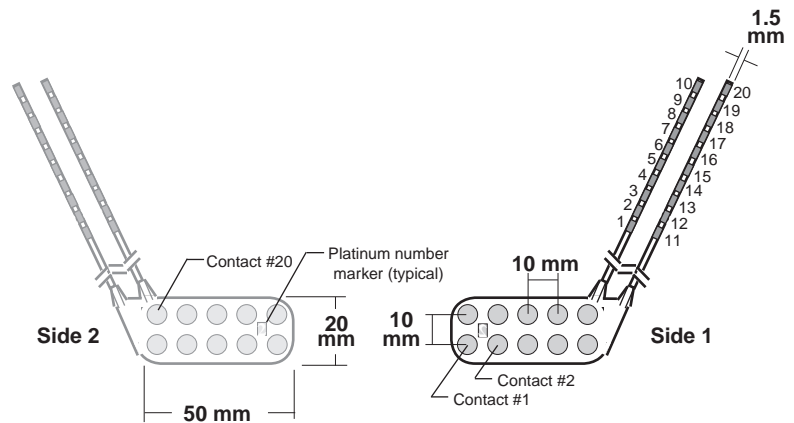

## Catalog #: DG32A-SP10X-V00

32-contact, 2x8, curved, dual-sided LTM grid.  
Platinum contacts.

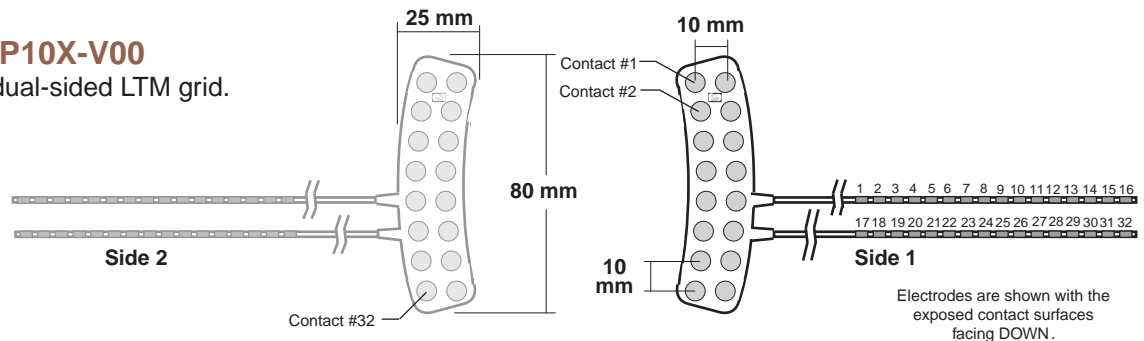

Catalog #	Description	CABRIO Cable	TECH-ATTACH Components		
			Cable	Block	Qty
DS08A-SP10X-000	1x4 dual strip	L-SRL-8DIN	L-DCL-8DIN	DC-8X	1
DS12A-SP10X-000	1x6 dual strip	L-SRL-12BDIN	L-DCL-12BDIN	DC-12X	1
DG20A-SP10X-U00	2x5 angled, dual grid	L-SRL-20DIN	L-DCL-20DIN	DC-10X	2
DG32A-SP10X-V00	2x8 curved, dual grid	L-SRL-32BDIN	L-DCL-32BDIN	DC-16X	2



# AD-TECH® IOM ELECTRODES WITH ATTACHED CABLES

- 6mm **platinum** indented contacts with 5mm exposure.
- Attached 1.8 meter cable.
- Sterile; single-use only.
- One-piece, easy to use.
- Includes random color code on body and tail.



INTRAOPERATIVE MONITORING

## Catalog #: FG08A-IP10X-0JH

8-contact, 2x4 large, 3D style IOM grid with attached 1.8m cable.

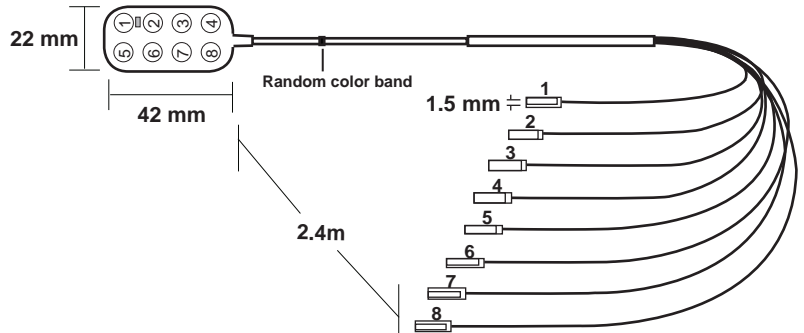

## Catalog #: MS04R-IP10X-0JH

4-contact, 1x4 large, 3D style IOM strip with attached 1.8m cable.

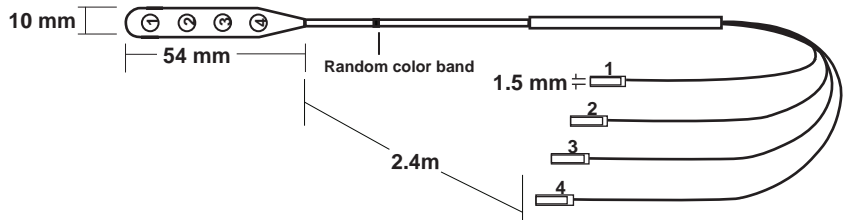

## Catalog #: MS06R-IP10X-0JH

6-contact, 1x6 large, 3D style IOM strip with attached 1.8m cable.

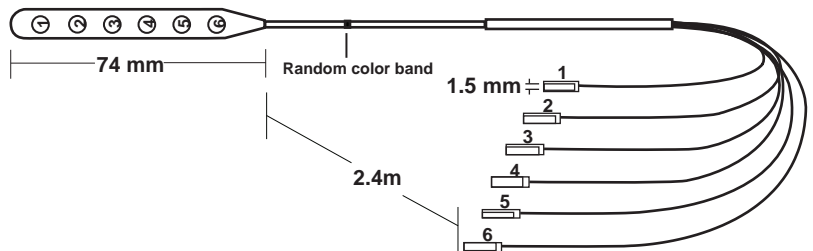

## Catalog #: MS08R-IP10X-0JH

8-contact, 1x8 large, 3D style IOM strip with attached 1.8m cable.

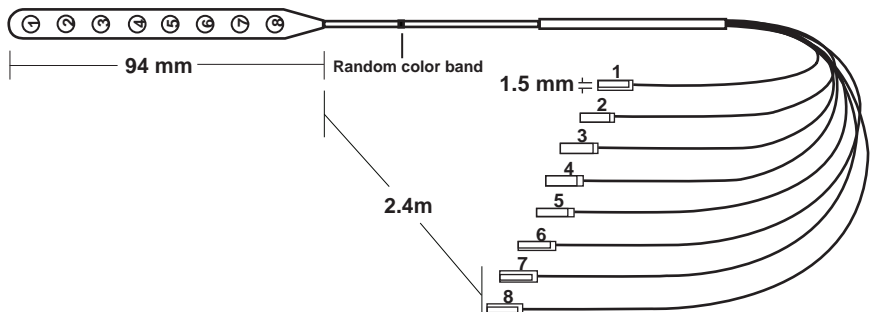

Electrodes are shown with the exposed contact surfaces facing DOWN.

Catalog #	Description
<b>FG08A-IP10X-0JH</b>	2x4 large, "3D" style grid with attached cable
<b>MS04R-IP10X-0JH</b>	1x4 large, "3D" style strip with attached cable
<b>MS06R-IP10X-0JH</b>	1x6 large, "3D" style strip with attached cable
<b>MS08R-IP10X-0JH</b>	1x8 large, "3D" style strip with attached cable

# AD-TECH® INTRAOPERATIVE MAPPING ELECTRODE SYSTEM

- The intraoperative mapping electrode system provides an alternative design for intraoperative monitoring.
- Clover-leaf electrode shape stabilizes the electrode contact on the brain.
- **Stainless steel** numbered contacts, 6.0mm diameter with 5.0mm exposure, 3D style.
- Sterile; single-use only.
- 1.5mm safety socket.

**Catalog #: VG04A-IS00X-0KH  
& VG04A-IS00X-0KG**  
4-contact numbered mapping electrode.  
Stainless steel contacts.

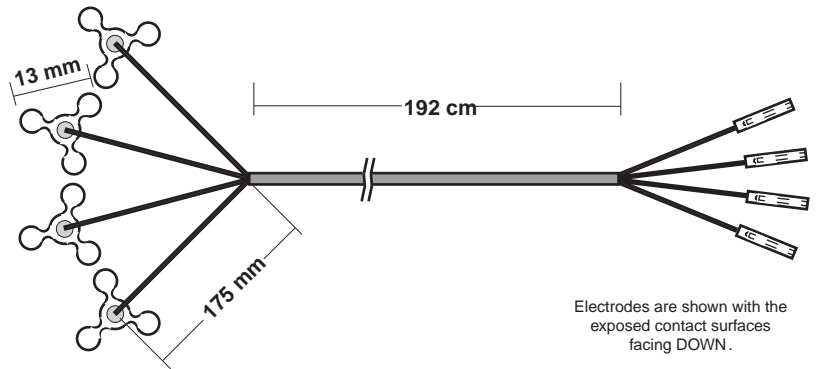

Catalog #	Description
VG04A-IS00X-0KG	Mapping electrode, numbered 1-4
VG04A-IS00X-0KH	Mapping electrode, numbered 5-8

INTRAOPERATIVE MONITORING

# AD-TECH® EPIDURAL SPINAL ELECTRODES

- For intraoperative monitoring of evoked potential (EPs) of the descending pathway during spinal surgery. D-Waves.
- 2 or 3 **platinum** contacts.
- Sterile; single-use only.
- Includes 16 gauge tuohy needle.
- Attached 1.2 meter cable.

**Catalog #: CEDL-2PDINX-101**  
2-contact spinal electrode with pre-attached lead and stylet. Platinum contacts.

**& CEDL-3PDINX-100**  
3-contact spinal electrode with pre-attached lead and stylet. Platinum contacts.

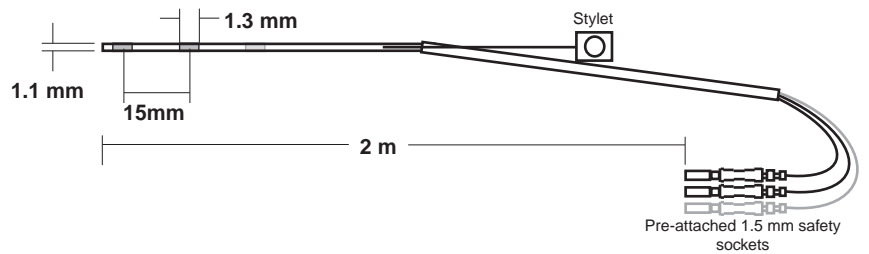

Catalog #	Description	Placement Qty
CEDL-2PDINX-101	2-contact spinal electrode	16 ga. Tuohy Needle + stylet
CEDL-3PDINX-100	3-contact spinal electrode	16 ga. Tuohy Needle + stylet

# AD-TECH® EPILEPSY/LTM SPENCER® PROBE DEPTH ELECTRODES

- For monitoring/mapping subsurface levels of the brain during the surgical treatment of epilepsy.
- **Platinum** contacts (Length: 2.41mm or 1.32mm).
- 1.12mm diameter.
- Contact spacing measured from center of contact to center of contact.
- Numbered and color coded for identification.
- 19cm marker.
- Includes stay flange for additional security.
- Sterile; single-use only.

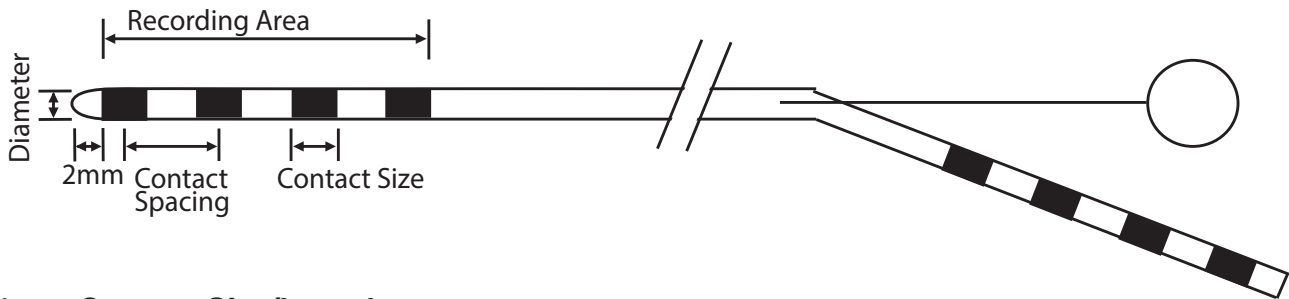

## 2.41mm Contact Size/Length

Part Number	# of Contacts	Contact Spacing	Recording Area	Overall Depth Length
SD04R-SP05X-000	4	5 mm	17 mm	360 mm
SD04R-SP10X-000	4	10 mm	32 mm	360 mm
SD06R-SP05X-000	6	5 mm	27 mm	370 mm
SD06R-SP10X-000	6	10 mm	52 mm	370 mm
SD08R-SP05X-000	8	5 mm	37 mm	380 mm
SD08R-SP10X-000	8	10 mm	72 mm	380 mm
SD10R-SP05X-000	10	5 mm	47 mm	390 mm
SD10R-SP10X-000	10	10 mm	92 mm	390 mm
SD12R-SP05X-000	12	5 mm	57 mm	400 mm
SD14R-SP05X-000	14	5 mm	67 mm	410 mm

## 1.32mm Contact Size/Length

Part Number	# of Contacts	Contact Spacing	Recording Area	Overall Depth Length
SD04R-AP58X-000	4	2.2 mm	8 mm	360 mm
SD06R-AP58X-000	6	2.2 mm	12 mm	370 mm
SD08R-AP58X-000	8	2.2 mm	17 mm	380 mm

## AD-TECH® EPILEPSY/LTM SPENCER® PROBE DEPTH ELECTRODES

- Used with Neuronavigational devices to help with accurate placement of depth electrodes.
- **Platinum** 1.27mm long contacts.
- 1.96mm diameter.
- Contact spacing measured from center of contact to center of contact.
- Numbered and color coded for identification.
- Sterile; single-use only.

### 1.27mm Contact Size/Length

Part Number	# of Contacts	Contact Spacing	Recording Area	Overall Depth Length
AD04R-SP10X-000	4	10 mm	31 mm	360 mm
AD04R-SP05X-000	4	5 mm	16 mm	360 mm
AD06R-SP05X-000	6	5 mm	26 mm	370 mm
AD08R-SP05X-000	8	5 mm	36 mm	380 mm

- sEEG Depth for monitoring/mapping subsurface levels of the brain during the surgical treatment of epilepsy.
- **Platinum** contacts (Length: 2.29mm).
- 0.86mm diameter.
- Contact spacing measured from center of contact to center of contact.
- Numbered and color coded for identification, 19cm marker.
- Depths with up to 10 contacts has stylet.
- Sterile; single-use only.
- CE up to 10 contacts.
- Special order. Please contact Ad-Tech for availability.

### 2.29mm Contact Size/Length

Part Number	# of Contacts	Contact Spacing	Recording Area	Overall Depth Length
RD06R-SP05X-000	6	5 mm	27 mm	370 mm
RD08R-SP04X-000	8	4 mm	30 mm	380 mm
RD08R-SP05X-000	8	5 mm	37 mm	380 mm
RD10R-SP03X-000	10	3 mm	29 mm	390 mm
RD10R-SP04X-000	10	4 mm	38 mm	390 mm
RD10R-SP05X-000	10	5 mm	47 mm	390 mm
RD10R-SP06X-000	10	6 mm	56 mm	390 mm
RD10R-SP07X-000	10	7 mm	65 mm	390 mm
RD10R-SP08X-000	10	8 mm	74 mm	390 mm



# AD-TECH® EPILEPSY/LTM BEHNKE FRIED DEPTH ELECTRODES

- For simultaneous macro and micro contact recordings.
- 8-contact macro recording outer body with 8 or 9-contact micro recording.
- **Platinum** contacts.
- Contact 1 starts 1.0 mm +/- 0.5 mm from body tip.
- Sterile; single-use only.

**Catalog #: BF08R-SP05X-000**  
8-contact macro depth electrode.

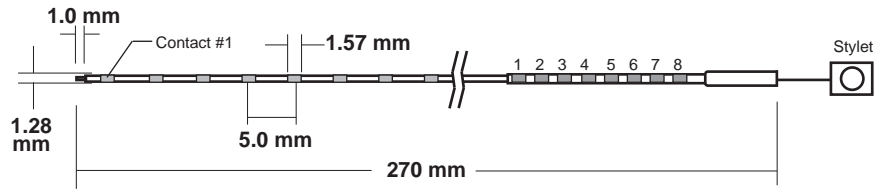

**Catalog #: WB09R-SP00X-014**  
9-contact micro-wire bundle  
(8 recording & 1 reference contact). Ends in "standard" pigtail.

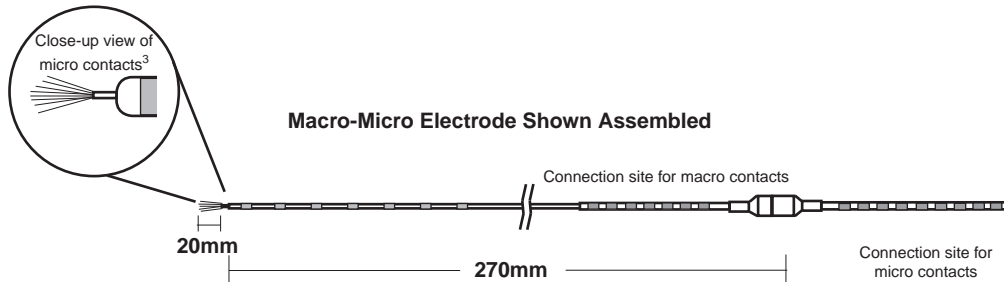
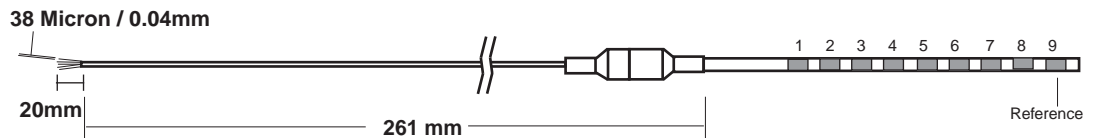

Catalog #	Description <sup>1</sup>	Contact Size <sup>2</sup>	TECH-ATTACH Components		Cable
			Cable	Block	
<b>BF08R-SP05X-000</b>	8-contact macro depth	1.57/1.28	L-DCL-8DIN	Included	n/a
<b>WB09R-SP00X-0B6</b>	9-contact micro depth	0.04	L-DCL-9DIN	DC-9X	L-SRL-9DIN
<b>WB09R-SP00X-014</b>	9-contact micro depth	0.04	L-DCL-9DIN	DC-9X	L-SRL-9DIN

<sup>1</sup> Each electrode requires the TECH-ATTACH or wire bundle cable as indicated. A special, slotted connector block that connects the macro contacts to the TECH-ATTACH cable is included with each BF-series electrode. Additional slotted blocks can be purchased, contact your Ad-Tech representative for catalog numbers and prices.

<sup>2</sup> Overall length of the contact followed by its diameter (mm).

<sup>3</sup> Micro wires extend 2 cm past the tip; trim to desired length prior to use.



# AD-TECH® EPILEPSY/LTM MACRO-MICRO DEPTH ELECTRODES

- For simultaneous macro and micro recordings of the deep brain structures.
- Sterile; single-use only.
- **Platinum** contacts.
- 1.3 mm diameter.
- 80% Platinum, 20% Iridium HML insulator.
- 50.8 Platinum Micron Wire.
- One piece design.
- Allow 6-8 weeks for delivery (made to order).

## Catalog #: MM16C-SP05X-000

16-Contact Macro-Micro Depth.  
6 macro contacts, 10 micro wires cut flush. 5mm spacing between macros.

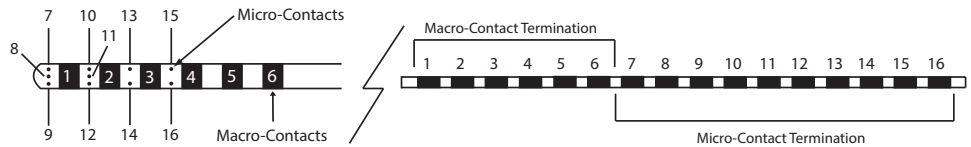

## Catalog #: MM16D-SP05X-000

16-Contact Macro-Micro Depth.  
8 macro contacts, 8 micro wires cut flush. 5mm spacing between macros.

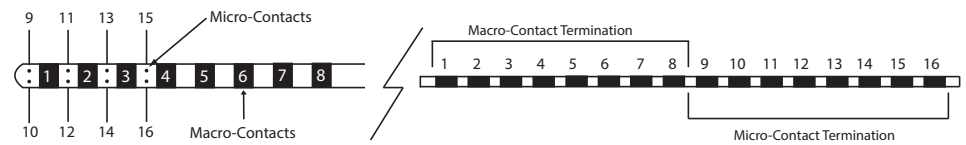

DEPTH ELECTRODES - MACRO/MICRO

Catalog #	Description	# of Macro Contacts	# of Micro Contacts
MM16C-SP05X-000	16-contact macro-micro depth	6	10
MM16D-SP05X-000	16-contact macro-micro depth	8	8

Many cable options are available for the micro recording tails.

Contact your Ad-Tech representative to discuss these options.

## AD-TECH® EPILEPSY/LTM FORAMEN OVALE ELECTRODES

- One piece body construction.
- 1.02 mm body diameter.
- Each set includes two foramen ovale electrodes, two 17 gauge (0.04 inch/1.016mm) introducing needles for placement, and two TECH-ATTACH connector blocks.
- Each set requires cable indicated.
- Uses FO-style TECH-ATTACH connection systems.
- 2.41 mm long, **platinum** contacts.
- Sterile; single-use only.

**Catalog #: FO04K-SP05X-000**  
4-contact FO set, 5mm spacing.

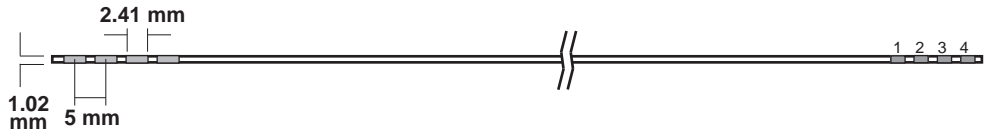

**Catalog #: FO06K-SP10X-000**  
6-contact FO set, 10mm spacing.

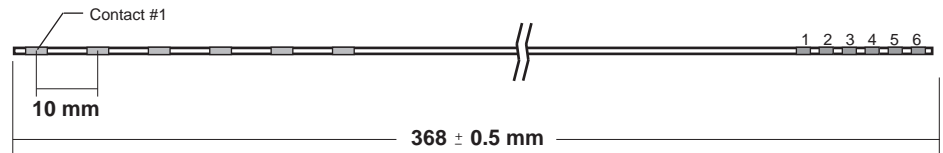

Catalog #	Description <sup>1</sup>	TECH-ATTACH Components	
		Cable	Block
FO04K-SP05X-000	4-contact FO set	FO-LDC-4DIN	Included
FO06K-SP10X-000	6-contact FO set	FO-LDC-6DIN	Included
FO06K-SP05X-000	6-contact FO set	FO-LDC-6DIN	Included

## AD-TECH® DEPTH ELECTRODE ANCHOR BOLTS

- For placement of depth electrodes with stereotactic or frameless systems.
- Sterile; single-use only.
- Titanium body (MRI friendly).
- Individually packaged, 3 per box.

**Catalog #: LSBK1-AX-05**  
2.5mm distal opening diameter. 21mm long.  
Use with SD style depth electrodes.

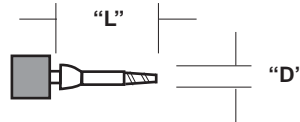

**Catalog #: LSBK2-AX-04**  
.99mm distal opening diameter. 21mm long.  
Gold Anodized.  
Use with RD style depth electrodes.

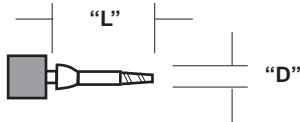

Catalog #	Description	Distal Opening Diameter "D"	Length "L"	Units
LSBK1-AX-05	Use with SD depth electrodes	2.5 mm	21 mm	3 Per Box
LSBK1-AX-06	Use with BF, LD or MM depth electrodes	2.5 mm	21 mm	3 Per Box
LSBK1-BX-05	Use with SD depth electrodes	2.5 mm	13 mm	3 Per Box
LSBK1-BX-06	Use with BF, LD or MM depth electrodes	2.5 mm	13 mm	3 Per Box
LSBK2-AX-04	Use with RD depth electrodes	0.99 mm	21 mm	3 Per Box
LSBK2-BX-04	Use with RD depth electrodes	0.99 mm	13 mm	3 Per Box

RD = Blue gasket  
SD = Green gasket  
LD/BF/MM = Clear gasket





**LEKSELL FRAME**

**PASSING NEEDLE**

CATALOG #	DESCRIPTION
LK-GB-N-13	Stainless Steel Drill Sleeve Blocks. <i>Non-Sterile, Re-Usable.</i>
SCSG-90-2.18N	Stainless Steel Slotted Cannula Guide. <i>Non-Sterile, Re-Usable.</i>
SCSG2-90-2.18N	Stainless Steel Slotted Cannula Guide for BF electrodes. <i>Non-Sterile, Re-Usable.</i>
2SCK1-190X	Two-Piece Slotted Cannula - 190mm (2.11 diameter) 2/Box <i>Sterile, Re-Usable.</i>
2SCK1-240X	Two-Piece Slotted Cannula - 240mm (2.11 diameter) 2/Box <i>Sterile, Re-Usable.</i>

**ANCHOR BOLTS**

CATALOG #	DESCRIPTION
LK-GB-N-13	Stainless Steel Drill Sleeve Blocks. <i>Non-Sterile, Re-Usable.</i>
DSG-6.3-090-2.4N	Guide for Drill & Placement/Removal Wrench (2.4mm diameter). <i>Non-Sterile, Re-Usable.</i>
DDK2-2.4-30X	2.4mm Drill Kit; (2) 30cm drill with stop and (2) wrenches. <i>Sterile, Single-Use Only.</i>
DDK2-2.4-16X	2.4mm Drill Kit; (2) 16cm drill with stop and (2) wrenches. <i>Sterile, Single-Use Only.</i>
LSB-PWL-2.4-10N	Placement/Removal Wrench for LSB series (24.5cm). <i>Non-sterile, Re-Usable.</i>
OB-20-190X	Obturator, used to make track inside brain - used with RD style anchor bolts. <i>Sterile, Reusable</i>
RULER-20N	20cm Channeled Ruler for drill stop & depth electrode measurement. <i>Non-Sterile, Re-Usable.</i>

**CRW FRAME**

Pictures of products on page 27

**PASSING NEEDLE**

CATALOG #	DESCRIPTION
SCSG-90-2.18N	Stainless Steel Slotted Cannula Guide. <i>Non-Sterile, Re-Usable.</i>
SCSG2-90-2.18N	Stainless Steel Slotted Cannula Guide for BF electrodes. <i>Non-Sterile, Re-Usable.</i>
2SCK1-190X	Two-Piece Slotted Cannula - 190mm (2.11 diameter) 2/Box <i>Sterile, Re-Usable.</i>
2SCK1-240X	Two-Piece Slotted Cannula - 240mm (2.11 diameter) 2/Box <i>Sterile, Re-Usable.</i>
RULER-20N	20cm Channeled Ruler for drill stop & depth electrode measurement. <i>Non-Sterile, Re-Usable.</i>

**ANCHOR BOLTS**

CATALOG #	DESCRIPTION
DSG-6.3-090-2.4N	Guide for Drill & Placement/Removal Wrench (2.4mm diameter). <i>Non-Sterile, Re-Usable.</i>
DDK2-2.4-30X	2.4mm Drill Kit; (2) 30cm drill with stop and (2) wrenches. <i>Sterile, Single-Use Only.</i>
DDK2-2.4-16X	2.4mm Drill Kit; (2) 16cm drill with stop and (2) wrenches. <i>Sterile, Single-Use Only.</i>
LSB-PWL-2.4-10N	Placement/Removal Wrench for LSB series (24.5cm). <i>Non-sterile, Re-Usable.</i>
OB-20-190X	Obturator, used to make track inside brain - used with RD style anchor bolts. <i>Sterile, Reusable.</i>
RULER-20N	20cm Channeled Ruler for drill stop & depth electrode measurement. <i>Non-Sterile, Re-Usable.</i>

Pictures of products on page 27

• Leksell Stereotactic System® & StealthStation® are registered trademarks of Elekta & Medtronic/Sofamor-Danek respectively. CRW™ and NaviVision™ are trademarks of Radionics & BrainLab.



# AD-TECH® PLACEMENT ACCESSORIES (CONTINUED)

## BRAIN LAB

### PASSING NEEDLE

CATALOG #	DESCRIPTION
<b>BLNG-2X</b>	Guide Tube to Fit BrainLab Neuronavigation system, used with slotted cannulas. <i>Sterile, Re-Usable.</i>
<b>2SCK1-190X</b>	Two-Piece Slotted Cannula - 190mm (2.11 diameter) 2/Box <i>Sterile, Re-Usable.</i>
<b>2SCK1-240X</b>	Two-Piece Slotted Cannula - 240mm (2.11 diameter) 2/Box <i>Sterile, Re-Usable.</i>
<b>RULER-20N</b>	20cm Channeled Ruler for drill stop & depth electrode measurement. <i>Non-Sterile, Re-Usable.</i>

### ANCHOR BOLTS

CATALOG #	DESCRIPTION
<b>DSG-6.3-090-2.4N</b>	Stainless Steel Drill (2.4mm drill) Sleeve/Placement Wrench Guide. <i>Non-Sterile, Re-Usable.</i>
<b>DDK2-2.4-30X</b>	2.4mm Drill Kit; (2) 30cm drill with stop and (2) wrenches. <i>Sterile, Single-Use Only.</i>
<b>DDK2-2.4-16X</b>	2.4mm Drill Kit; (2) 16cm drill with stop and (2) wrenches. <i>Sterile, Single-Use Only.</i>
<b>LSB-PWL-2.4-10N</b>	Placement/Removal Wrench for LSB series (24.5cm). <i>Non-Sterile, Re-Usable.</i>
<b>OB-20-190X</b>	Obturator, used to make track inside brain - used with RD style anchor bolts. <i>Sterile, Reusable.</i>
<b>RULER-20N</b>	20cm Channeled Ruler for drill stop & depth electrode measurement. <i>Non-Sterile, Re-Usable.</i>

## MEDTRONIC STEALTH

Pictures of products on page 27

### PASSING NEEDLE

CATALOG #	DESCRIPTION
<b>SNG-AX</b>	Guide Tube to Fit Stealth Neuronavigation system, used with slotted cannulas. <i>Sterile, Re-Usable.</i>
<b>2SCK1-190X</b>	Two-Piece Slotted Cannula - 190mm (2.11 diameter) 2/Box <i>Sterile, Re-Usable.</i>
<b>2SCK1-240X</b>	Two-Piece Slotted Cannula - 240mm (2.11 diameter) 2/Box <i>Sterile, Re-Usable.</i>
<b>RULER-20N</b>	20cm Channeled Ruler for drill stop & depth electrode measurement. <i>Non-Sterile, Re-Usable.</i>

### ANCHOR BOLTS

CATALOG #	DESCRIPTION
<b>DDK2-2.4-30X</b>	2.4mm Drill Kit; (2) 30cm drill with stop and (2) wrenches. <i>Sterile, Single-Use Only.</i>
<b>DDK2-2.4-16X</b>	2.4mm Drill Kit; (2) 16cm drill with stop and (2) wrenches. <i>Sterile, Single-Use Only.</i>
<b>LSB-PWL-2.4-10N</b>	Placement/Removal Wrench for LSB series (24.5cm). <i>Non-Sterile, Re-Usable.</i>
<b>OB-20-190X</b>	Obturator, used to make track inside brain - used with RD style anchor bolts. <i>Sterile, Reusable.</i>
<b>RULER-20N</b>	20cm Channeled Ruler for drill stop & depth electrode measurement. <i>Non-Sterile, Re-Usable.</i>

Pictures of products on page 27

• Leksell Stereotactic System® & StealthStation® are registered trademarks of Elekta & Medtronic/Sofamor-Danek respectively. CRW™ and NaviVision™ are trademarks of Radionics & BrainLab.



## AD-TECH® PLACEMENT ACCESSORIES (CONTINUED)

### ROSA ROBOT

ANCHOR BOLTS	
CATALOG #	DESCRIPTION
DDK2-2.4-30X	2.4mm Drill Kit; (2) 30cm drill with stop and (2) wrenches. <i>Sterile, Single-Use Only.</i>
DDK2-2.4-16X	2.4mm Drill Kit; (2) 16cm drill with stop and (2) wrenches. <i>Sterile, Single-Use Only.</i>
LSB-PWL-2.4-10N	Placement/Removal Wrench for LSB series (24.5cm). <i>Non-Sterile, Re-Usable.</i>
OB-20-190X	Obturator, used to make track inside brain - used with RD style anchor bolts. <i>Sterile, Reusable.</i>
RULER-20N	20cm Channeled Ruler for drill stop & depth electrode measurement. <i>Non-Sterile, Re-Usable.</i>

### NEUROMATE ROBOT

ANCHOR BOLTS	
CATALOG #	DESCRIPTION
DDK2-2.4-30X	2.4mm Drill Kit; (2) 30cm drill with stop and (2) wrenches. <i>Sterile, Single-Use Only.</i>
LSB-PWL-2.4-10N	Placement/Removal Wrench for LSB series (24.5cm). <i>Non-Sterile, Re-Usable.</i>
OB-20-190X	Obturator, used to make track inside brain - used with RD style anchor bolts. <i>Sterile, Reusable.</i>
RULER-20N	20cm Channeled Ruler for drill stop & depth electrode measurement. <i>Non-Sterile, Re-Usable.</i>

### FHC STarFIX

ANCHOR BOLTS	
CATALOG #	DESCRIPTION
DDK2-2.4-30X	2.4mm Drill Kit; (2) 30cm drill with stop and (2) wrenches. <i>Sterile, Single-Use Only.</i>
LSB-PWL-2.4-10N	Placement/Removal Wrench for LSB series (24.5cm). <i>Non-Sterile, Re-Usable.</i>
OB-20-190X	Obturator, used to make track inside brain - used with RD style anchor bolts. <i>Sterile, Reusable.</i>
RULER-20N	20cm Channeled Ruler for drill stop & depth electrode measurement. <i>Non-Sterile, Re-Usable.</i>

• ROSA™ is a trademark of Medtech; neuromate® is a registered trademark of Renishaw. STarFIX™ and microTargeting™ are trademarks of FHC, Inc.

PLACEMENT ACCESSORY PRODUCT DRAWINGS

PLACEMENT ACCESSORIES

CATALOG #	PART		
LK-GB-N-13	<i>Guide Blocks</i> <ul style="list-style-type: none"> <li>• Leksell Frame</li> <li>• Non-sterile</li> <li>• Reusable</li> </ul>		
SCSG-90-2.18N	<i>Slotted Cannula Guide</i> <ul style="list-style-type: none"> <li>• Non-Sterile</li> <li>• Reusable</li> </ul>	For use with: RD & SD style depths	
SCSG2-90-2.18N	<i>Slotted Cannula Guide</i> <ul style="list-style-type: none"> <li>• Non-Sterile</li> <li>• Reusable</li> </ul>	For use with: BF & MM style depths	
2SCK1-240X 2SCK1-190X	<i>Slotted Cannula</i> <ul style="list-style-type: none"> <li>• Sterile</li> <li>• Reusable</li> </ul>	For use with: RD & SD style depths	
RULER-20N	<i>Ruler</i> <ul style="list-style-type: none"> <li>• Non-sterile</li> <li>• Reusable</li> </ul>		
DSG-6.3-090-2.4N	<i>Drill Sleeve Guide</i> <ul style="list-style-type: none"> <li>• For 2.4mm Drill</li> <li>• Non-Sterile</li> <li>• Reusable</li> </ul>	For use with: RD, SD, & 1 tail MM style depths	
DDK2-2.4-30X DDK2-2.4-16X	<i>Drill Kit</i> <ul style="list-style-type: none"> <li>• Sterile</li> <li>• Single use only</li> </ul>		
OB-20-190X	<i>Obturator</i> <ul style="list-style-type: none"> <li>• Sterile</li> <li>• Reusable</li> </ul>		
LSB-PWL-2.4-10N	<i>Anchor Bolt Placement/ Removal Wrench</i> <ul style="list-style-type: none"> <li>• Non-Sterile</li> <li>• Reusable</li> </ul>	For use with: LSB Bolts Series	
SNG-AX	<i>Medtronic Depth Guide Tube</i> <ul style="list-style-type: none"> <li>• Sterile</li> <li>• Reusable</li> </ul>	For use with: RD & SD style depths	
BLNG-2X	<i>Brain Lab Depth Guide</i> <ul style="list-style-type: none"> <li>• Sterile</li> <li>• Reusable</li> </ul>	For use with: RD & SD style depths	

- RD: Reduced diameter depth (0.86mm diameter)
- SD: Standard depth (1.1mm diameter)
- MM: Macro-Micro depth (1.3mm diameter)

## AD-TECH® DISPOSABLE DRILL KITS

- Each kit includes two drills, two drill stops, and two adjustment wrenches.
- For drilling cranial holes using a stereotactic frame.
- Stainless steel construction.
- 30cm or 16cm long.
- Sterile; single-use only.

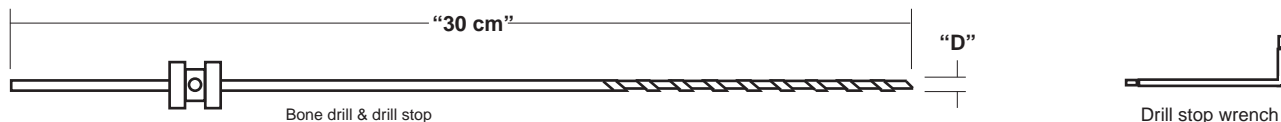

Catalog #	Description	Diameter "D"	Units
DDK2-2.4-30X	Use with LSB bolts, 30cm long	2.4 mm	2 Per Box
DDK2-2.8-30X	Use with BAB and DGL bolts, 30cm long	2.8 mm	2 Per Box
DDK2-2.4-16X	Use with LSB bolts, 16cm long	2.4 mm	2 Per Box

## AD-TECH® PASSING NEEDLES

- For tunneling the electrode wire carriers or "tails" away from the surgical site.
- Individually packaged.
- Sterile; single-use only.

### Catalog #: APNK1-3.5X

Passing needle. 2.4mm diameter. 3.5 inch length. (5/Box).



### Catalog #: LPNK1-10X

Single-tail passing needle. 6.4mm diameter. 10 inch length. (For use with single-tail electrode dividing into 3 or more tails). (2/Box).

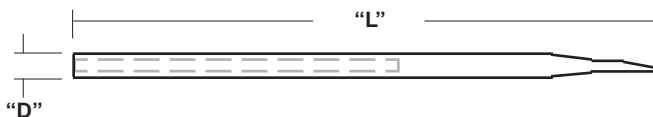

### Catalog #: BPNK1-10X

Bent single-tail passing needle. 6.4mm diameter. 10 inch length. (For use with single-tail electrode dividing into 3 or more tails). (2/Box)

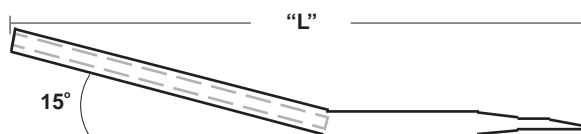

### & BPNK2-10X

Bent single-tail passing needle. 5.1mm diameter. 10.25 inch length. (For use with single tail electrodes dividing into 2 tails). (2/Box)

Catalog #	Description	Diameter "D"	Length "L"	Units
APNK1-3.5X	Passing needle	13 ga. (2.4mm)	3.5 in (8.9 cm)	5 Per Box
LPNK1-10X	Single-tail passing needle	0.25 in (6.4mm)	10 in (25.4 cm)	2 Per Box
BPNK1-10X	Bent single-tail passing needle	0.25 in (6.4mm)	10 in (25.4 cm)	2 Per Box
BPNK2-10X	Bent single-tail passing needle	0.20 in (5.1mm)	10.25 in (26 cm)	2 Per Box

■ LPNK1-10X and BPNK1-10X are for 3 or more tails. BPNK2-10X are for 2 tails.



# AD-TECH® LIGHTWEIGHT ELECTRODE CONNECTION SYSTEMS

- Lightweight & flexible.
- 1.8 meter (6 feet) length - additional cable lengths available.
- Quick disconnect option available.

## Lightweight CABRIO Connection System

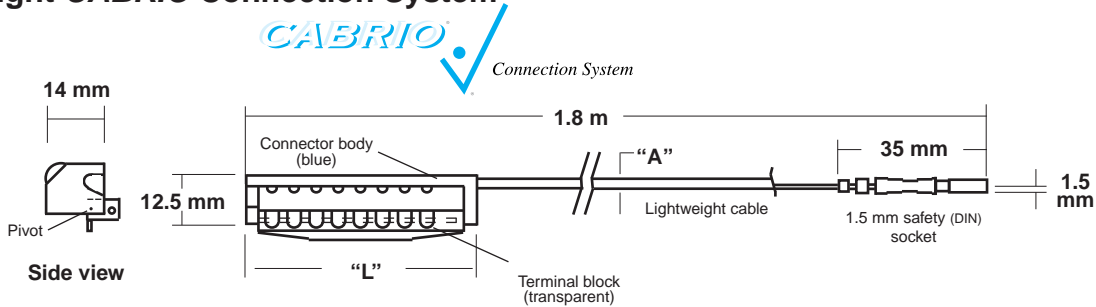

Catalog #	Description	Terminal Configuration	Dimension "L"	Cable Diameter "A"
L-SRL-4DIN	4-contact lightweight CABRIO connector/cable	1 terminal of 4	34 mm	2.21 mm
L-SRL-6DIN	6-contact lightweight CABRIO connector/cable	1 terminal of 6	44 mm	2.67 mm
L-SRL-8DIN	8-contact lightweight CABRIO connector/cable	1 terminal of 8	54 mm	2.67 mm
L-SRL-9DIN	9-contact lightweight CABRIO connector/cable	1 terminal of 9	64 mm	3.23 mm
L-SRL-10DIN	10-contact lightweight CABRIO connector/cable	1 terminal of 10	64 mm	3.23 mm
L-SRL-12BDIN	12-contact lightweight CABRIO connector/cable	1 terminal of 12	94 mm	3.76 mm
L-SRL-16BDIN	16-contact lightweight CABRIO connector/cable	1 terminal of 16	94 mm	3.76 mm
L-SRL-20DIN	20-contact lightweight CABRIO connector/cable	2 terminals of 10	64 mm	2 x 3.23 mm
L-SRL-32BDIN	32-contact lightweight CABRIO connector/cable	2 terminals of 16	94 mm	2 x 3.76 mm
L-SRL-48BDIN	48-contact lightweight CABRIO connector/cable	3 terminals of 16	94 mm	3 x 3.76 mm
L-SRL-64BDIN	64-contact lightweight CABRIO connector/cable	4 terminals of 16	94 mm	4 x 3.76 mm

## Lightweight TECH-ATTACH Connection System

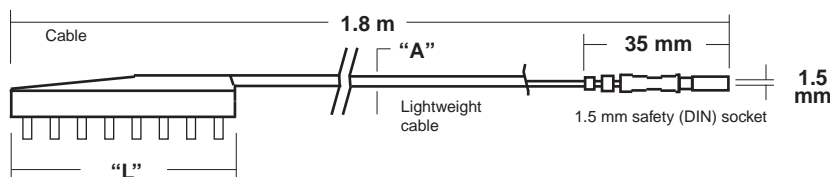

Catalog #	Description	Terminal Configuration	Dimension "L"	Cable Diameter "A"
L-DCL-4DIN	4-contact lightweight TECH-ATTACH cable	1 terminal of 4	34 mm	2.21 mm
L-DCL-6DIN	6-contact lightweight TECH-ATTACH cable	1 terminal of 6	44 mm	2.67 mm
L-DCL-8DIN	8-contact lightweight TECH-ATTACH cable	1 terminal of 8	54 mm	2.67 mm
L-DCL-9DIN	9-contact lightweight TECH-ATTACH cable	1 terminal of 9	64 mm	3.23 mm
L-DCL-10DIN	10-contact lightweight TECH-ATTACH cable	1 terminal of 10	64 mm	3.23 mm
L-DCL-12BDIN	12-contact lightweight TECH-ATTACH cable	1 terminal of 12	94 mm	3.76 mm
L-DCL-16BDIN	16-contact lightweight TECH-ATTACH cable	1 terminal of 16	94 mm	3.76 mm
L-DCL-20DIN	20-contact lightweight TECH-ATTACH cable	2 terminals of 10	64 mm	2 x 3.23 mm
L-DCL-32BDIN	32-contact lightweight TECH-ATTACH cable	2 terminals of 16	94 mm	2 x 3.76 mm
L-DCL-48BDIN	48-contact lightweight TECH-ATTACH cable	3 terminals of 16	94 mm	3 x 3.76 mm
L-DCL-64BDIN	64-contact lightweight TECH-ATTACH cable	4 terminals of 16	94 mm	4 x 3.76 mm

- Lightweight CABRIO and TECH-ATTACH cables are supplied with 1.5 mm safety sockets. Where not prohibited by law, alternative termination options are available upon request. Non-sterile; sterilize via EtO (EO) or Sterrad. All lightweight TECH-ATTACH cables require the use of disposable connector blocks.



## AD-TECH® LIGHTWEIGHT QUICK DISCONNECT CABLES

- ODU Connector allowing for quick disconnect of the cable.
- Great for OR Monitoring.
- Please allow 10-12 days for delivery (made to order).
- Contact Ad-Tech to inquire about additional available lengths.

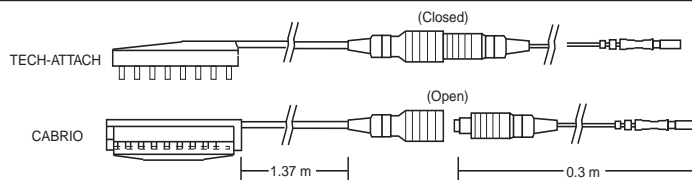

Catalog #	Description	Terminal Configuration	Dimension "L"	Cable Diameter "A"
L-SRL-4DIN-10	4-contact lightweight CABRIO connector/cable	1 terminal of 4	34 mm	2.21 mm
L-SRL-8DIN-10	8-contact lightweight CABRIO connector/cable	1 terminal of 8	54 mm	2.67 mm
L-SRL-16BDIN-10	16-contact lightweight CABRIO connector/cable	1 terminal of 16	94 mm	3.76 mm
L-SRL-20DIN-10	20-contact lightweight CABRIO connector/cable	2 terminals of 10	64 mm	2 x 3.23 mm
L-SRL-32BDIN-10	32-contact lightweight CABRIO connector/cable	2 terminals of 16	94 mm	2 x 3.76 mm
L-SRL-48BDIN-10	48-contact lightweight CABRIO connector/cable	3 terminals of 16	94 mm	3 x 3.76 mm
L-SRL-64BDIN-10	64-contact lightweight CABRIO connector/cable	4 terminals of 16	94 mm	4 x 3.76 mm
L-DCL-4DIN-10	4-contact lightweight TECH-ATTACH cable	1 terminal of 4	34 mm	2.21 mm
L-DCL-6DIN-10	6-contact lightweight TECH-ATTACH cable	1 terminal of 6	44 mm	2.67 mm
L-DCL-8DIN-10	8-contact lightweight TECH-ATTACH cable	1 terminal of 8	54 mm	2.67 mm
L-DCL-10DIN-10	10-contact lightweight TECH-ATTACH cable	1 terminal of 10	64 mm	3.23 mm
L-DCL-12DIN-10	12-contact lightweight TECH-ATTACH cable	2 terminals of 6	66 mm	3.76 mm
L-DCL-16BDIN-10	16-contact lightweight TECH-ATTACH cable	1 terminal of 16	94 mm	3.76 mm
L-DCL-20DIN-10	20-contact lightweight TECH-ATTACH cable	2 terminals of 10	64 mm	2 x 3.23 mm
L-DCL-24DIN-10	24-contact lightweight TECH-ATTACH cable	3 terminals of 8	94 mm	2 x 3.76 mm
L-DCL-32BDIN-10	32-contact lightweight TECH-ATTACH cable	2 terminals of 16	94 mm	3 x 3.76 mm
L-DCL-48BDIN-10	48-contact lightweight TECH-ATTACH cable	3 terminals of 16	94 mm	3 x 3.76 mm
L-DCL-64BDIN-10	64-contact lightweight TECH-ATTACH cable	4 terminals of 16	94 mm	4 x 3.76 mm

## AD-TECH® DISPOSABLE CONNECTOR BLOCKS

### TECH-ATTACH Disposable Connector Blocks

(Box of 10). Sterile.

■ All TECH-ATTACH connector blocks are packaged in sets of two with five sets per box. Sold by box of ten only. Sterile; single-use only.

Catalog #	Description	Used with Lightweight TECH-ATTACH Cable
DC-2X	2-contact block	L-DC-2DIN
DC-3X	3-contact block	L-DCL-3DIN
DC-4X	4-contact block	L-DCL-4DIN
DC-5X	5-contact block	L-DCL-5DIN
DC-6X	6-contact block	L-DCL-6DIN
DC-8X	8-contact block	L-DCL-8DIN, -16DIN, -32DIN, -48DIN, -64DIN
DC-10X	10-contact block	L-DCL-10DIN, -20DIN, -40BDIN
DC-11X	11-contact block	L-DCL-35DIN
DC-12X	12-contact block	L-DCL-12BDIN, -24BDIN, -35DIN & -48DDIN
DC-16X	16-contact block	L-DCL-16BDIN, -32BDIN, -48BDIN & -64BDIN



# AD-TECH® DISPOSABLE BRAIN BIOPSY NEEDLES

- Supplied as complete kits (needle stop & aspirator tube with Luer lock; 10 cm models also include a barium sleeve).
- Available in standard lengths: 10 cm, 19 cm & 24 cm.
- Inner and outer cannula have polished, rounded closed ends.
- 14 gauge (0.083 inch/ 2.11 mm) diameter.
- Nominal 8 mm side cutting window; optional 5 mm side cutting window.
- Also available in MR-conditional.
- 304 stainless steel with 1 cm markings.
- Sterile; single-use only.

MISCELLANEOUS PRODUCTS

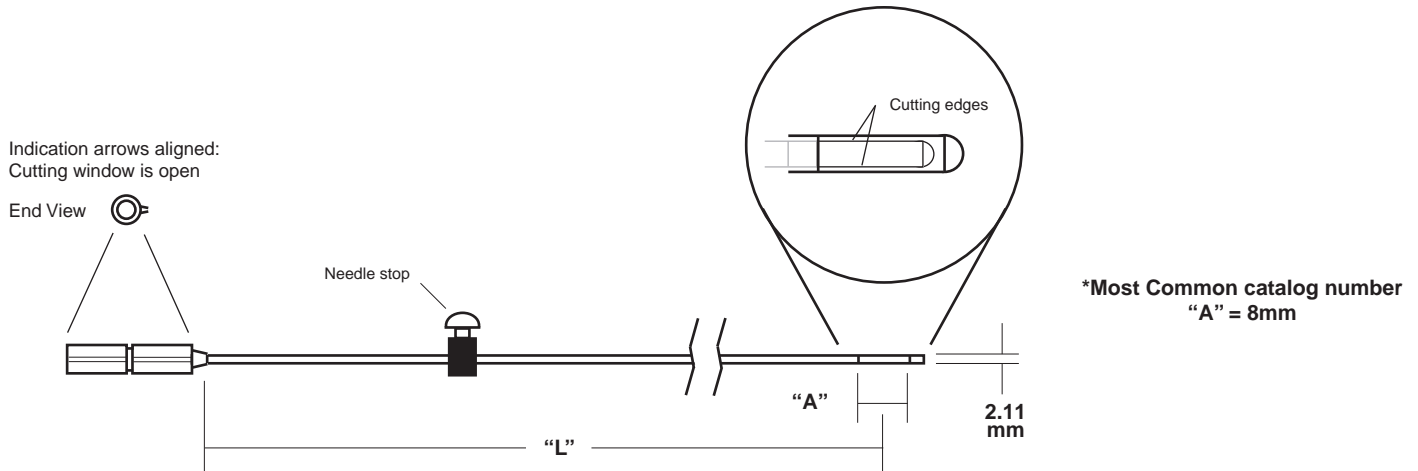

Catalog #	Description	Dimension "L"	Units
DBN-05-19X	Biopsy needle	19 cm	1 Per Box
DBN-08-10X	Biopsy needle	10 cm	1 Per Box
DBN-08-19X	Biopsy needle	19 cm	1 Per Box
DBN-08-24X	Biopsy needle	24 cm	1 Per Box
MDBN-08-28X	MR-Conditional biopsy needle	28 cm	1 Per Box



# AD-TECH® CUEVA INTRAOPERATIVE CRANIAL NERVE ELECTRODES

- For direct cranial nerve monitoring during skull base surgeries.
- Circumferential design, 2.0 mm or 3.0 diameter “C-Shaped” electrode.
- Supplied in complete sterile kits. Each kit includes two 2.0 mm or 3.0 mm cranial electrodes, two 25 cm long applicator wands, and two 6 foot (1.8 m) lead wires terminating in a 1.5 mm safety socket.
- All lead wires interface with standard EEG/EP amplifiers using 1.5 mm safety sockets.
- Platinum contacts.
- Easy-to-use applicator, 250 mm long.
- Highly-consistent amplitude; real-time status.
- Sterile; single-use only.
- Not CE Marked.

## Catalog #: CNE1-2KDINX

2mm cranial nerve electrode kit.

## & CNE1-3KDINX

3mm cranial nerve electrode kit.

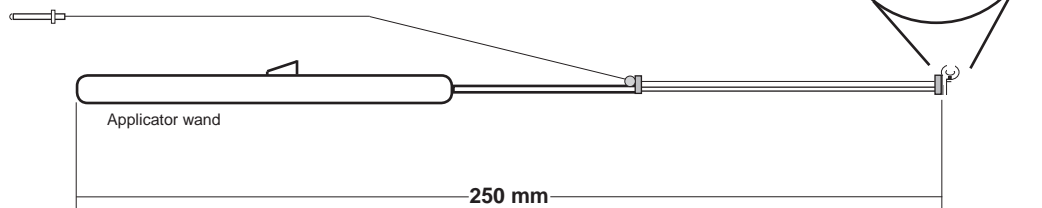

Cranial nerve electrode lead wire  
(EEG interface cable)

Catalog #	Description	Units
CNE1-2KDINX	2mm cranial nerve electrode kit	2 Per Box
CNE1-3KDINX	3mm cranial nerve electrode kit	2 Per Box

## AD-TECH® SUBPIAL TRANSECTORS

- Lightweight & disposable.
- Two different 0.55 mm diameter tip styles (dull & sharp).
- Bent distal portion of all tips is approximately 5 mm long.
- Sterile; single-use only.
- Individually packaged.
- Ad-Tech's Subpial Transectors are not CE marked.

### Catalog #: MST-D03X

Pre-attached dull tip. (3/Box).

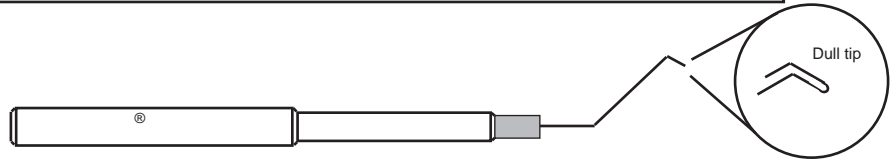

### Catalog #: MST-S03X

Pre-attached sharp tip. (3/Box).

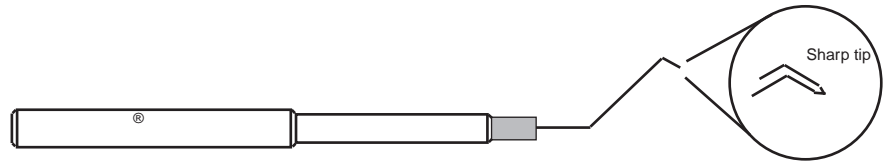

Catalog #	Description <sup>1</sup>
MST-D03X	MST handle with pre-attached dull tip. Box of three individually sterilized units
MST-S03X	MST handle with pre-attached sharp tip. Box of three individually sterilized units

## AD-TECH® EPILEPSY/LTM SPHENOIDAL ELECTRODES

- Supplied as kits (2 electrodes, 2 introducing needles, & 2 lead wires).
- Two needle lengths available - 2.0 inches (51 mm) & 2.75 inches (70 mm) long.
- 0.011 inch (0.28 mm) **stainless steel** or 0.007 inch (0.18 mm) **platinum** wire, 30 cm in length; un-insulated 3-4 mm tip.
- 21 gauge (0.033 inch/0.84 mm) needle; other introducing needles available upon request.
- Sterile; single-use only.

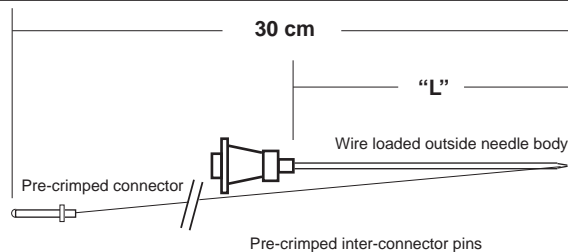

Catalog #	Description <sup>1</sup>	Inter-Connector Pin Style	Wire Location	Wire Diameter	Needle Length Dimension "L"
711-1DINX-01	Sphenoidal electrode kit	pre-attached	outside needle	0.011 in (0.28 mm)	2.75 in (70 mm)
711-1DINX-05	Sphenoidal electrode kit	pre-attached	outside needle	0.011 in (0.28 mm)	2.00 in (51 mm)
711-1PDINX-01	Sphenoidal electrode kit	pre-attached	outside needle	0.007 in (0.18 mm)	2.75 in (70 mm)
711-1PDINX-05	Sphenoidal electrode kit	pre-attached	outside needle	0.007 in (0.18 mm)	2.00 in (51 mm)

# POLICIES

**CONTACT INFORMATION:** To contact Ad-Tech, please call, fax, or e-mail us at the addresses found at the bottom of the page. To email orders, please email: [customersupport@adtechmedical.com](mailto:customersupport@adtechmedical.com).

**ORDERING INFORMATION:** Ad-Tech accepts the following forms of payment:

- American Express, MasterCard or Visa
- Wire Transfers
- ACH

**SHIPPING INFORMATION:** Ad-Tech will ship your order using UPS or FEDEX. Shipping/Handling charges depend on the dimensional weight, value and destination of the item(s). Shipping is FOB Ad-Tech and is prepaid and added to the invoice. Other shipping methods or carriers may be available.

**TERMS & CONDITIONS:** Payment terms are Net 30 Days. Unpaid balances are subject to a 1.5% per month finance charge.

**STANDARD POLICIES:** The purchaser agrees to comply with Ad-Tech's standard policies pertaining to Returned Goods, Product Traceability, Medical Device Reporting and Customer Complaints, as well as with all applicable Laws & Restrictions of the USA Export Administration and of the purchaser's country. Contact Ad-Tech for additional information.

**RESTOCKING:** All returns for credit are subject to a restocking charge. Contact Ad-Tech prior to returning any product.

**RETURNED GOODS:** A Return Authorization Number is required prior to returning product to Ad-Tech. Unauthorized shipments without an RMA number may not be accepted. Contact Ad-Tech for details.

**PURCHASER'S/END-USER'S REMEDIES:** The Purchaser's/End-User's sole and exclusive remedy shall be the replacement of the product by Ad-Tech, free of charge. Contact Ad-Tech for additional warranty information.

**LATEX STATEMENT:** Ad-Tech's products are not manufactured with natural rubber latex.

**CE MARKINGS:** Please contact Ad-Tech for a complete list of CE Marked products.

**SPECIFICATIONS:** All specifications and claims are subject to change without notice.

**ASSISTANCE:** Assistance from Ad-Tech is available 24 hours a day, 365 days per year.

**CANADA:** Devices advertised in this catalog may not have been licensed in accordance with Canadian law.

All products may be covered by one or more of the following USA Patents:

5,375,594 - 6,004,262 - 6,415,168  
6,629,900 - 6,656,152 - 6,671,534  
7,134,919 - 7,241,283 - 7,255,686  
7,277,742 - 7,322,954 - 7,425,142  
7,465,292 - 7,536,215 - 7,607,224  
7,608,064

Foreign Patents and Patents Pending



**AD-TECH** MEDICAL INSTRUMENT CORPORATION

1901 WILLIAM STREET, RACINE, WI 53404 U.S.A.

Phone: 262-634-1555 Email: [sales@adtechmedical.com](mailto:sales@adtechmedical.com)

Fax: 262-634-5668 Website: [www.adtechmedical.com](http://www.adtechmedical.com)



**Toll Free: 800-776-1555**



# Product Catalog

Volume VII

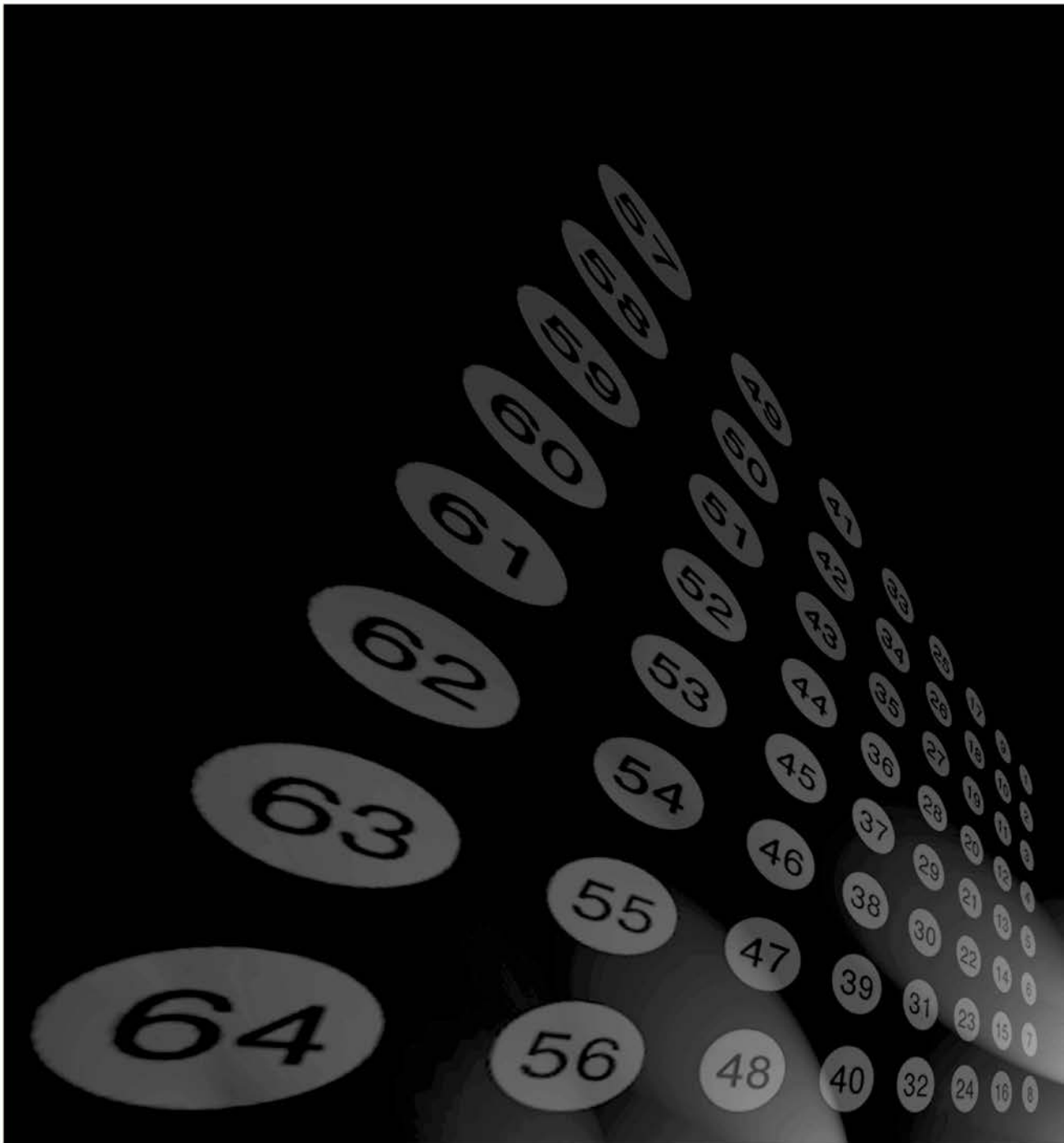

**MEDICAL INSTRUMENT CORPORATION**  
1901 WILLIAM STREET, RACINE, WISCONSIN 53404 U.S.A.  
Phone: 262.634.1555      Email: [sales@adtechmedical.com](mailto:sales@adtechmedical.com)  
Fax: 262.634.5668      Website: [www.adtechmedical.com](http://www.adtechmedical.com)

**Toll Free (U.S.A.): 800.776.1555**