

AdTech Product Catalogue

Severn Healthcare Technologies Limited

WELCOME!

Welcome to Ad-Tech's catalog of products for the surgical treatment of epilepsy and for neurosurgery. We wish to thank you for your support and for choosing Ad-Tech.

PURPOSE OF ELECTRODES

The Ad-Tech subdural, depth, and sphenoidal electrodes are intended for temporary (<30 days) use with recording, monitoring and stimulation equipment, for the recording, monitoring, and stimulation of electrical signals on the surface level of the brain. The recording of electrical activity supports definition of the location of epileptogenic foci and brain mapping.



Severn Healthcare Technologies Limited

38 Kingfisher Court, Hambridge Road
Newbury, Berkshire RG14 5SJ

Telephone: 01635 887640 Fax: 01635 41227

Email: service@severnhealthcare.com

severnhealthcare.com

TABLE OF CONTENTS

	PAGE
FREQUENTLY ORDERED ITEMS	4
SUBDURAL ELECTRODES	
Subdural Strip Electrodes.....	5
Narrow-Body Subdural Strip Electrodes.....	6
IOM Subdural Strip Electrodes.....	7
“L” & “T” Shaped Subdural Strip & Grid Electrodes.....	8
“3D” Style Subdural Strip Electrodes.....	9
Contoured Subdural Grid Electrodes.....	10
Subdural Grid Electrodes.....	11-12
Perpendicular-Tail Subdural Grid Electrodes.....	13
Temporal Lobe Subdural Grid Electrodes.....	14
Single-Tail Subdural Grid Electrodes.....	15
Multi-Strip & Split-Grid Subdural Electrodes.....	16
Dual-Sided Interhemispheric Subdural Electrodes.....	17
INTRAOPERATIVE MONITORING (IOM)	
IOM Electrodes with Attached Cables.....	18
IOM Mapping Electrode System.....	19
Epidural Spinal Electrodes.....	19
DEPTH ELECTRODES	
Spencer® Probe Depth Electrodes.....	20-21
Behnke Fried Depth Electrodes.....	22
Macro-Micro Depth Electrodes.....	23
Foramen Ovale Electrodes.....	24
PLACEMENT ACCESSORIES	
Depth Electrode Anchor Bolts.....	24
Depth Electrode Placement Accessories.....	25-27
Disposable Drill Kits.....	28
Passing Needles.....	28
CONNECTION SYSTEMS	
Lightweight Electrode Connection Systems.....	29
Lightweight Quick Disconnect Cables.....	30
Disposable Connector Blocks.....	30
MISCELLANEOUS PRODUCTS	
Disposable Brain Biopsy Needles.....	31
Cueva Intraoperative Cranial Nerve Electrodes.....	32
Subpial Transectors.....	33
Sphenoidal Electrodes.....	33

Strip Electrodes

Catalog #: TS04R-SP10X-000
4-contact, 1x4 LTM strip. Non-numbered.
with reinforcement. Platinum, 10 mm spacing.

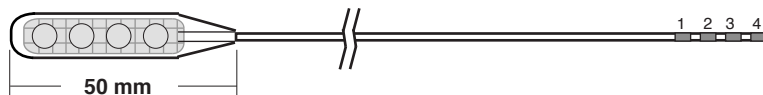

Catalog #: IS04R-SP10X-000
4-contact, 1x4 IOM strip. Numbered.
Platinum, 10 mm spacing.

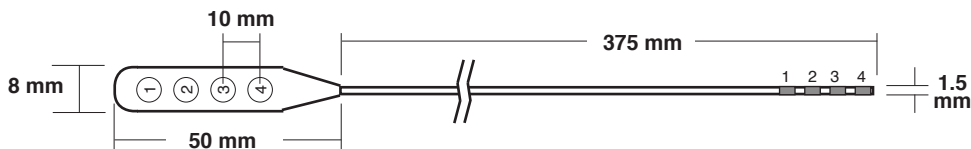

Grid Electrodes

Catalog #: FG20C-SP10X-000
20-contact, 4x5 LTM grid, 2 tails.
Platinum, 10 mm spacing.

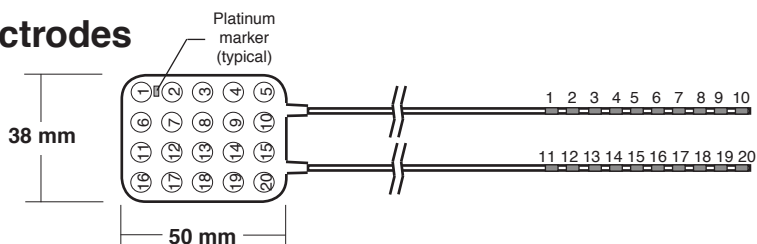

Catalog #: FG64C-SP10X-0C6
64-contact, 8x8 LTM grid, 4 tails.
Platinum, 10 mm spacing, Scallops & slits.

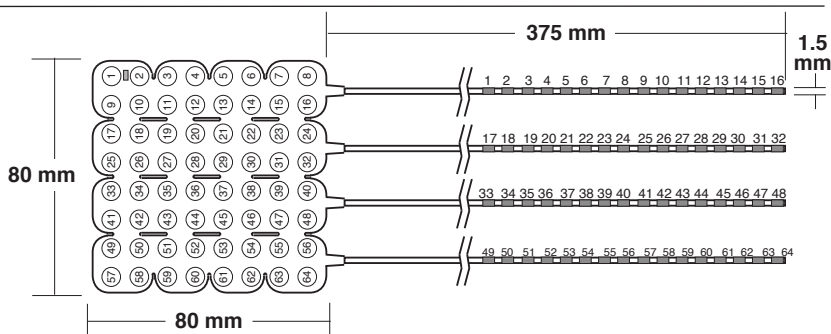

IOM Electrodes with Cables Attached

Catalog #: MS04R-IP10X-0JH
4-contact, 1x4 IOM strip, 6mm contacts.
Platinum, 10 mm spacing.
Attached 1.8m cable

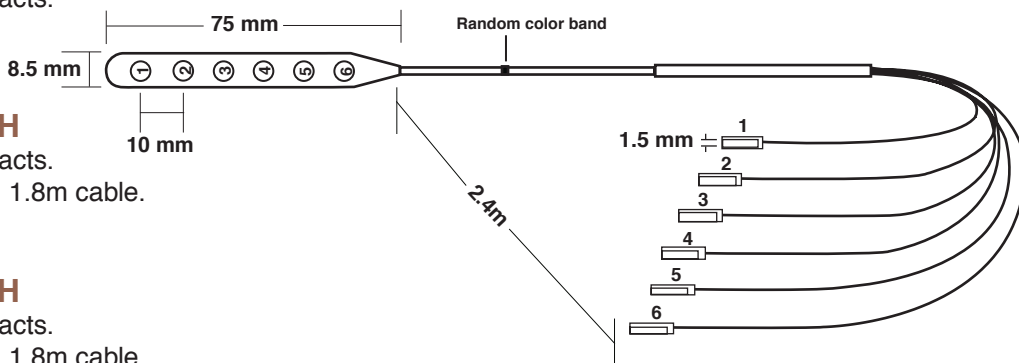

Catalog #: MS06R-IP10X-0JH
6-contact, 1x6 IOM strip, 6mm contacts.
Platinum, 10 mm spacing. Attached 1.8m cable.
Pictured to the right.

Catalog #: MS08R-IP10X-0JH
8-contact, 1x8 IOM strip, 6mm contacts.
Platinum, 10 mm spacing. Attached 1.8m cable.

Depth Electrodes

Catalog #: SD04R-SP05X-000
4-contact depth, 5mm spacing.
Pictured to the right.

Catalog #: SD06R-SP05X-000
6-contact depth, 5mm spacing.

Catalog #: SD08R-SP05X-000
8-contact depth, 5mm spacing.



severn EPILEPSY/LTM SUBDURAL STRIP ELECTRODES

- 8mm width.
- Thin and flexible.
- **Platinum** or **stainless steel** contacts, 4.0mm diameter with 2.3mm exposure.
- Non-numbered with reinforcement, designed for long-term monitoring applications.
- Sterile; single-use only.

Catalog #: **TS02R-SP10X-000**
& TS02R-SS10X-000
 2-contact, 1x2 LTM strip. 10mm spacing.

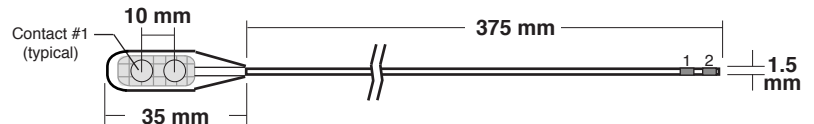

Catalog #: **TS04R-SP10X-000**
& TS04R-SS10X-000
 4-contact, 1x4 LTM strip. 10mm spacing.

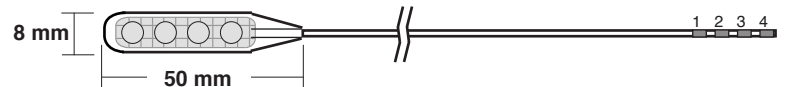

Catalog #: **TS04R-SP15X-000**
& TS04R-SS15X-000
 4-contact, 1x4 LTM strip. 15mm spacing.

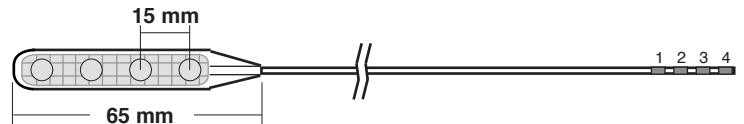

Catalog #: **TS06R-SP10X-000**
& TS06R-SS10X-000
 6-contact, 1x6 LTM strip. 10mm spacing.

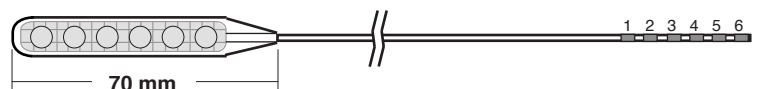

Catalog #: **TS08R-SP10X-000**
& TS08R-SS10X-000
 8-contact, 1x8 LTM strip. 10mm spacing.

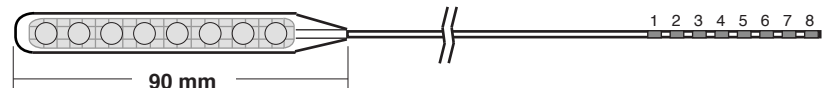

Catalog #: **TS10R-SP10X-000**
& TS10R-SS10X-000
 10-contact, 1x10 LTM strip. 10mm spacing.

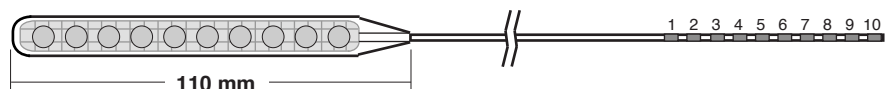

Catalog #: **TS12R-SP10X-000**
& TS12R-SS10X-000
 12-contact, 1x12 LTM strip. 10mm spacing.

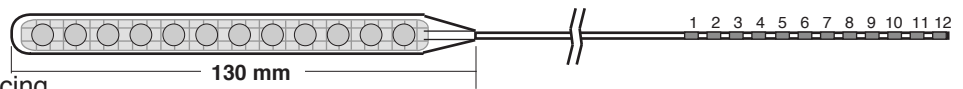

Electrodes are shown with the exposed contact surfaces facing DOWN.

Platinum	Catalog #		Description	CABRIO Cable	TECH-ATTACH Components		
	Platinum	Stainless Steel			Cable	Block	Qty
	TS02R-SP10X-000	TS02R-SS10X-000	1x2 LTM strip	L-SRL-2DIN	L-DCL-2DIN	DC-2X	1
	TS04R-SP10X-000	TS04R-SS10X-000	1x4 LTM strip	L-SRL-4DIN	L-DCL-4DIN	DC-4X	1
	TS04R-SP15X-000	TS04R-SS15X-000	1x4 LTM strip	L-SRL-4DIN	L-DCL-4DIN	DC-4X	1
	TS06R-SP10X-000	TS06R-SS10X-000	1x6 LTM strip	L-SRL-6DIN	L-DCL-6DIN	DC-6X	1
	TS08R-SP10X-000	TS08R-SS10X-000	1x8 LTM strip	L-SRL-8DIN	L-DCL-8DIN	DC-8X	1
	TS10R-SP10X-000	TS10R-SS10X-000	1x10 LTM strip	L-SRL-10DIN	L-DCL-10DIN	DC-10X	1
	TS12R-SP10X-000	TS12R-SS10X-000	1x12 LTM strip	L-SRL-12BDIN	L-DCL-12BDIN	DC-12X	1

severn EPILEPSY/LTM NARROW-BODY SUBDURAL STRIP ELECTRODES

- 4.0mm contact diameter with reduced contact exposure (1.8mm).
- Non-numbered with reinforcement, designed for long-term monitoring applications.
- **Platinum** contacts.
- Thin and flexible.
- 6mm width.
- Sterile; single-use only.

Catalog #: TS04R-AP10X-0W6
4-contact, 1x4 narrow-body LTM strip.
Platinum contacts, 10mm spacing.

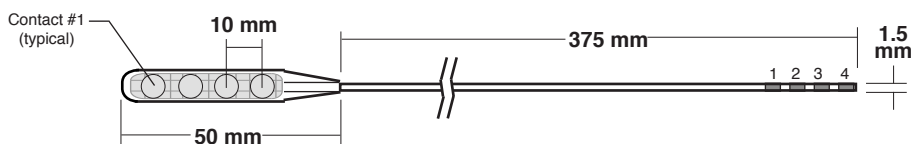

Catalog #: TS06R-AP10X-0W6
6-contact, 1x6 narrow-body LTM strip.
Platinum contacts, 10mm spacing.

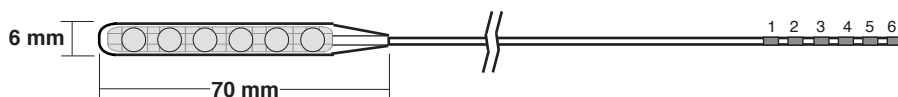

Catalog #: TS08R-AP10X-0W6
8-contact, 1x8 narrow-body LTM strip.
Platinum contacts, 10mm spacing.

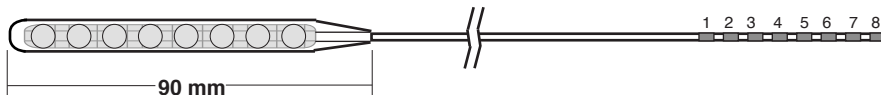

Electrodes are shown with the exposed contact surfaces facing DOWN.

Catalog #	Description	CABRIO Cable	TECH-ATTACH Components		
			Cable	Block	Qty
TS04R-AP10X-0W6	1x4 narrow-body strip	L-SRL-4DIN	L-DCL-4DIN	DC-4X	1
TS06R-AP10X-0W6	1x6 narrow-body strip	L-SRL-6DIN	L-DCL-6DIN	DC-6X	1
TS08R-AP10X-0W6	1x8 narrow-body strip	L-SRL-8DIN	L-DCL-8DIN	DC-8X	1

severn INTRAOPERATIVE MONITORING SUBDURAL STRIP ELECTRODES

- Intraoperative monitoring electrodes feature numbered contacts, greater visibility of the recording surface, and greater flexibility of the electrode contact area.
- **Platinum** or **stainless steel** numbered contacts, 4.0mm diameter with 2.3mm exposure.
- Sterile; single-use only.

Catalog #: IS04R-SP10X-000 & IS04R-SS10X-000

4-contact, 1x4 IOM strip.

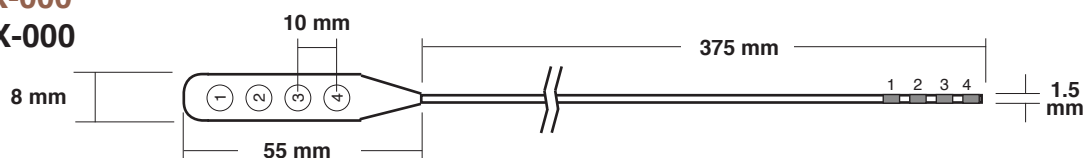

Catalog #: IS06R-SP10X-000 & IS06R-SS10X-000

6-contact, 1x6 IOM strip.

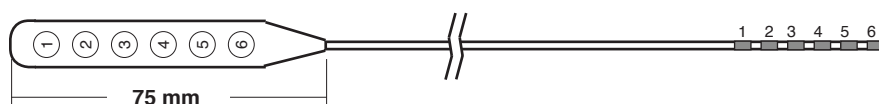

Catalog #: IS08R-SP10X-000 & IS08R-SS10X-000

8-contact, 1x8 IOM strip.

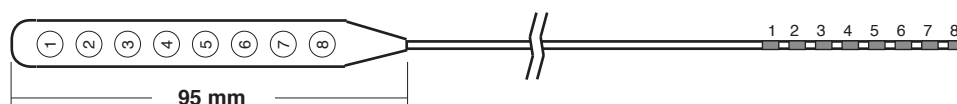

Electrodes are shown with the exposed contact surfaces facing DOWN.

Catalog #		Description	CABRIO Cable	TECH-ATTACH Components		
Platinum	Stainless Steel			Cable	Block	Qty
IS04R-SP10X-000	IS04R-SS10X-000	1x4 IOM strip	L-SRL-4DIN	L-DCL-4DIN	DC-4X	1
IS06R-SP10X-000	IS06R-SS10X-000	1x6 IOM strip	L-SRL-6DIN	L-DCL-6DIN	DC-6X	1
IS08R-SP10X-000	IS08R-SS10X-000	1x8 IOM strip	L-SRL-8DIN	L-DCL-8DIN	DC-8X	1

- Numbered, **platinum** contacts with platinum markers as shown, 4.0mm diameter with 2.3mm exposure.
- “L” and “T” shapes offer you different tail-exit options
- 37.5cm tail length.
- Sterile; single-use only.

Catalog #: MS08L-SP10X-A00

8-contact, reversed “L” shaped LTM strip.
Platinum contacts, 10mm spacing.

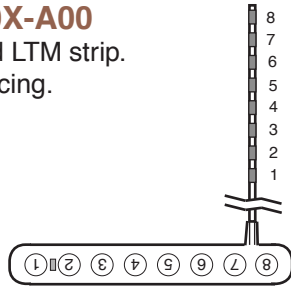

Catalog #: MS08I-SP10X-B00

8-contact, “L” shaped LTM strip.
Platinum contacts, 10mm spacing.

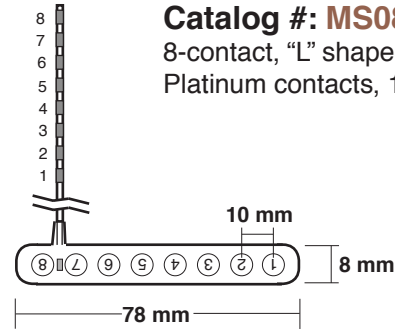

Catalog #: MS08L-SP10X-E00

8-contact, curved reversed “L” shaped LTM strip. Platinum contacts, 10mm spacing.

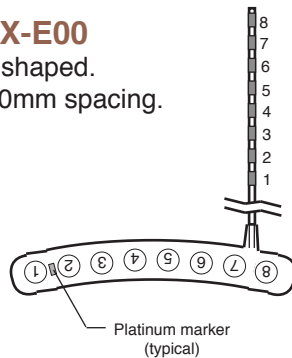

Catalog #: MS08I-SP10X-F00

8-contact, curved “L” shaped LTM strip. Platinum contacts, 10mm spacing.

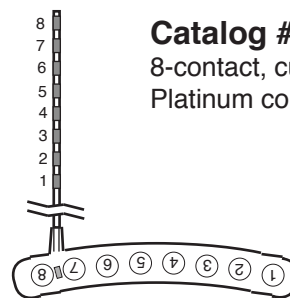

Catalog #: MS08R-SP10X-C00

8-contact, “T” shaped LTM strip.
Platinum contacts, 10mm spacing.

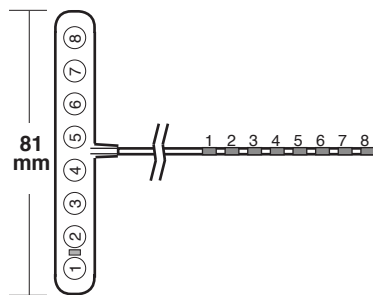

Electrodes are shown with the exposed contact surfaces facing DOWN.

Catalog #	Description	CABRIO Cable	TECH-ATTACH Components		
			Cable	Block	Qty
MS08L-SP10X-A00	Reversed “L” shaped LTM strip	L-SRL-8DIN	L-DCL-8DIN	DC-8X	1
MS08I-SP10X-B00	“L” shaped LTM strip	L-SRL-8DIN	L-DCL-8DIN	DC-8X	1
MS08L-SP10X-E00	Curved, reversed “L” LTM strip	L-SRL-8DIN	L-DCL-8DIN	DC-8X	1
MS08I-SP10X-F00	Curved “L” shaped LTM strip	L-SRL-8DIN	L-DCL-8DIN	DC-8X	1
MS08R-SP10X-C00	“T” shaped LTM strip	L-SRL-8DIN	L-DCL-8DIN	DC-8X	1

severn EPILEPSY/LTM “3D” STYLE SUBDURAL STRIP ELECTRODES

- Large, indented 6.0mm diameter contacts with 5.0mm diameter exposed recording area.
- Numbered, **platinum** contacts.
- 10mm contact spacing.

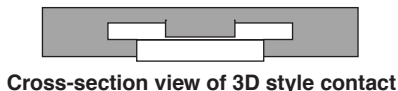

Catalog #: MS04R-IP10X-000

4-contact, 1x4 “3D” style strip.
Platinum contacts.

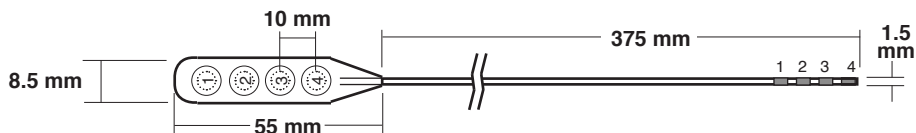

Catalog #: MS06R-IP10X-000

6-contact, 1x6 “3D” style strip.
Platinum contacts.

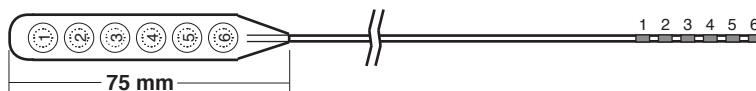

Catalog #: MS08R-IP10X-000

8-contact, 1x8 “3D” style strip.
Platinum contacts.

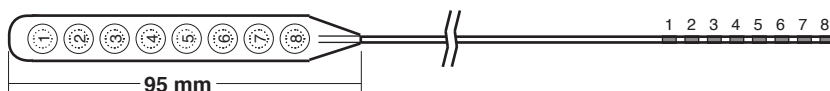

Electrodes are shown with the exposed contact surfaces facing DOWN.

Catalog #	Description	CABRIO Cable	TECH-ATTACH Components		
			Cable	Block	Qty
MS04R-IP10X-000	1x4 large, “3D” style platinum strip	L-SRL-4DIN	L-DCL-4DIN	DC-4X	1
MS06R-IP10X-000	1x6 large, “3D” style platinum strip	L-SRL-6DIN	L-DCL-6DIN	DC-6X	1
MS08R-IP10X-000	1x8 large, “3D” style platinum strip	L-SRL-8DIN	L-DCL-8DIN	DC-8X	1

severn EPILEPSY/LTM CONTOURED SUBDURAL GRID ELECTRODES

- Contoured shape may provide more flexibility to conform to the brain. Contact Ad-Tech to inquire if your preferred grid can also be contoured.
- Numbered, **platinum** contacts, 4.0mm diameter with a 2.3mm exposure.
- May be used with the single-tail passing needles.
- 10mm contact spacing is standard; additional spacing options available.
- Sterile; single-use only.

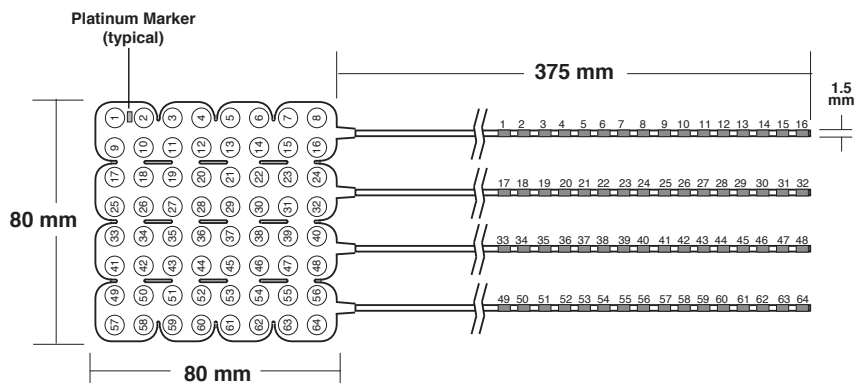

Catalog #: **FG64C-SP10X-0C6**
64-contact, 8x8, 4 tail LTM contoured grid.
Platinum contacts.

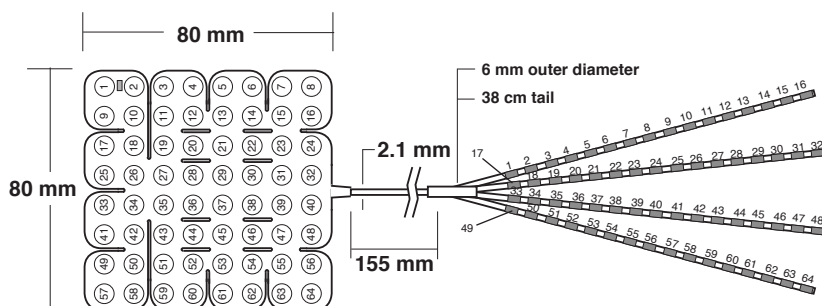

Catalog #: **FG64C-SP10X-0CB**
64-contact, 8x8, single-tail LTM contoured grid.
Platinum contacts.

Electrodes are shown with the exposed contact surfaces facing DOWN.

Catalog #	Description	CABRIO Cable	TECH-ATTACH Components		
			Cable	Block	Qty
FG64C-SP10X-0C6	8x8, 4-tail LTM contoured grid	L-SRL-64BDIN	L-DCL-64BDIN	DC-16X	4
FG64C-SP10X-0CB	8x8, single-tail LTM contoured grid	L-SRL-64BDIN	L-DCL-64BDIN	DC-16X	4

severn EPILEPSY/LTM SUBDURAL GRID ELECTRODES

- Epilepsy/LTM subdural electrodes are for monitoring/mapping the cortical surface for the surgical treatment of epilepsy.
- Numbered, **platinum** or **stainless steel** contacts, 4.0mm diameter with 2.3mm exposure, 10mm contact spacing (unless otherwise noted).
- Sterile; single-use only.
- Most electrodes can be manufactured contoured and slit upon request.

**Catalog #: FG08A-SP10X-000
& FG08A-SS10X-000**
8-contact, 2x4, single-tail LTM grid.

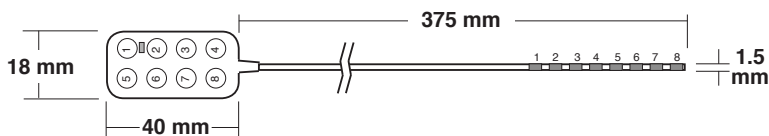

**Catalog #: FG16A-SP10X-000
& FG16A-SS10X-000**
16-contact, 2x8, single-tail LTM grid.

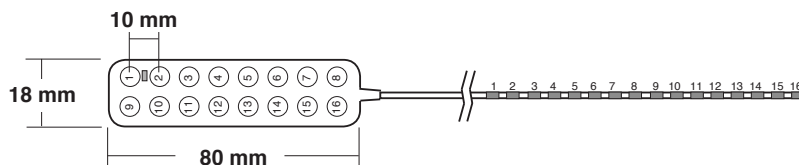

**Catalog #: FG20C-SP10X-000
& FG20C-SS10X-000**
20-contact, 4x5, 2-tail LTM grid.

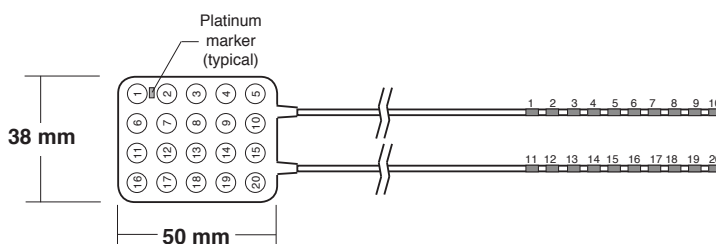

**Catalog #: FG32C-SP10X-000
& FG32C-SS10X-000**
32-contact, 4x8, 2-tail LTM grid.

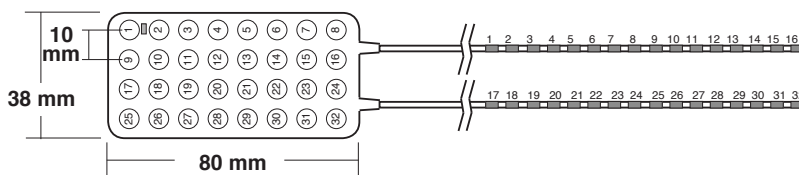

Electrodes are shown with the exposed contact surfaces facing DOWN.

Catalog #		Description	CABRIO Cable	TECH-ATTACH Components		
Platinum	Stainless Steel			Cable	Block	Qty
FG08A-SP10X-000	FG08A-SS10X-000	2x4, single-tail LTM grid	L-SRL-8DIN	L-DCL-8DIN	DC-8X	1
FG16A-SP10X-000	FG16A-SS10X-000	2x8, single-tail LTM grid	L-SRL-16BDIN	L-DCL-16BDIN	DC-16X	1
FG20C-SP10X-000	FG20C-SS10X-000	4x5, 2-tail LTM grid	L-SRL-20DIN	L-DCL-20DIN	DC-10X	2
FG32C-SP10X-000	FG32C-SS10X-000	4x8, 2-tail LTM grid	L-SRL-32BDIN	L-DCL-32BDIN	DC-16X	2

severn  **EPILEPSY/LTM SUBDURAL GRID ELECTRODES (CONTINUED)**

Catalog #: FG48G-SP10X-000 & FG48G-SS10X-000

48-contact, 6x8, 3-tails LTM grid.
10mm contact spacing.

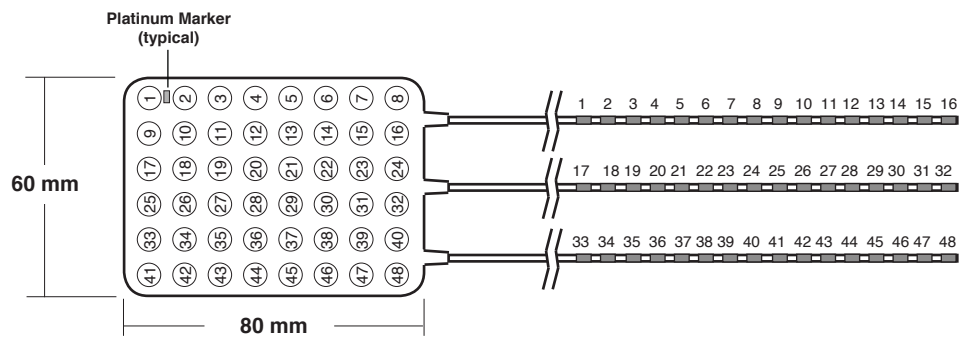

Catalog #: FG64C-SP10X-000 & FG64C-SS10X-000

64-contact, 8x8, 4-tails LTM grid.
10mm contact spacing.

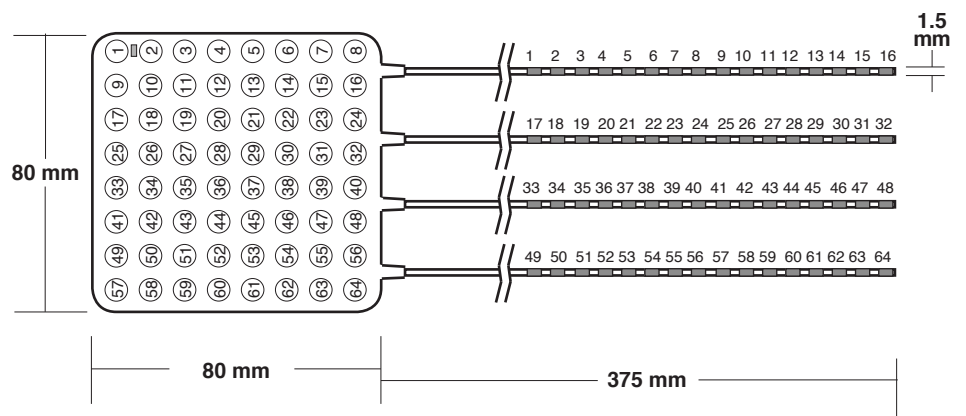

Catalog #: FG64C-SP05X-000 & FG64C-SS05X-000

64-contact, 8x8, 4-tails LTM grid.
5mm contact spacing.

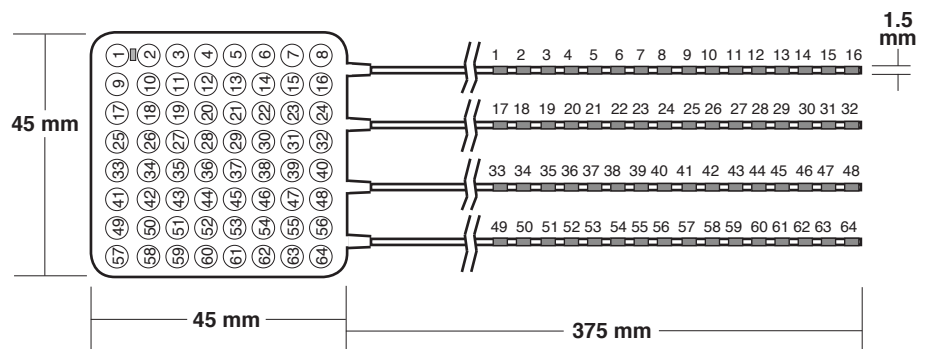

Electrodes are shown with the exposed contact surfaces facing DOWN.



Catalog #		Description	CABRIO Cable	TECH-ATTACH Components		
Platinum	Stainless Steel			Cable	Block	Qty
FG48G-SP10X-000	FG48G-SS10X-000	6x3, 3-tail LTM grid	L-SRL-48BDIN	L-DCL-48BDIN	DC-16X	3
FG64C-SP10X-000	FG64C-SS10X-000	8x8, 4-tail LTM grid	L-SRL-64BDIN	L-DCL-64BDIN	DC-16X	4
FG64C-SP05X-000	FG64C-SS05X-000	8x8, 4-tail LTM grid	L-SRL-64BDIN	L-DCL-64BDIN	DC-10X	4

severn  **EPILEPSY/LTM PERPENDICULAR-TAIL SUBDURAL GRID ELECTRODES**

- Perpendicular tail design may allow for a smaller craniotomy.
- Numbered, **platinum** contacts, 4.0mm contacts with 2.3mm exposure.
- Sterile; single-use only.
- Also available contoured and slit.

Catalog #: FG64C-SP10X-006

64-contact, 8x8, 4-tails 90° from center,
Tails positioned closer together. LTM grid.
Platinum contacts.

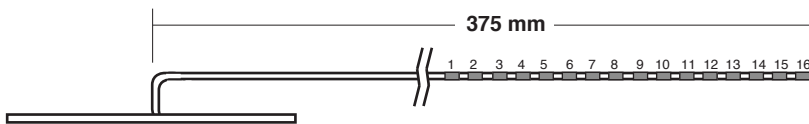
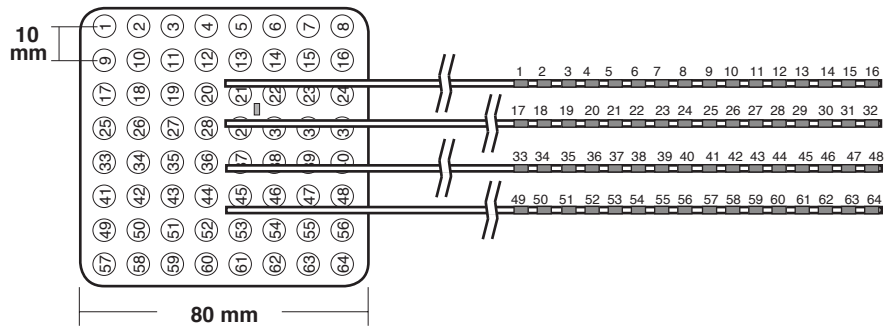

Side view of FG64C-SP10X-006

Electrodes are shown with the exposed contact surfaces facing DOWN.

Catalog #	Description	CABRIO Cable	TECH-ATTACH Components		
			Cable	Block	Qty
FG64C-SP10X-006	8x8, 4-tail 90°-center LTM grid	L-SRL-64BDIN	L-DCL-64BDIN	DC-16X	4

- Right and left temporal lobe electrodes are designed for the temporal and sub-temporal cortex.
- Numbered, **platinum** contacts, 4.0mm diameter with 2.3mm exposure.
- Sterile; single-use only.

Catalog #: FG35D-SP10X-Z00
35-contact right temporal lobe LTM grid.
Platinum contacts.

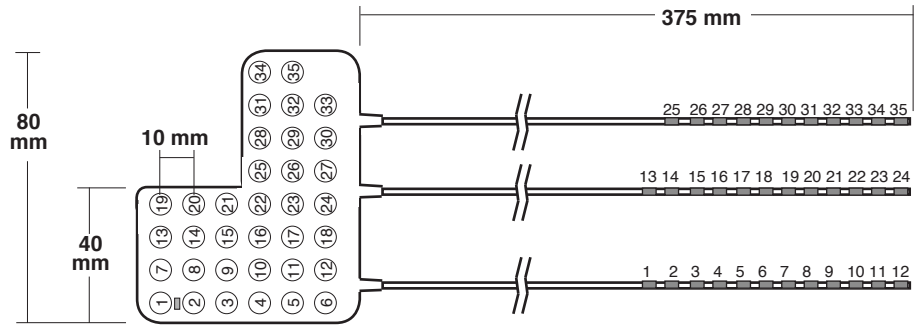

Catalog #: FG35E-SP10X-Z00
35-contact left temporal lobe LTM grid.
Platinum contacts.

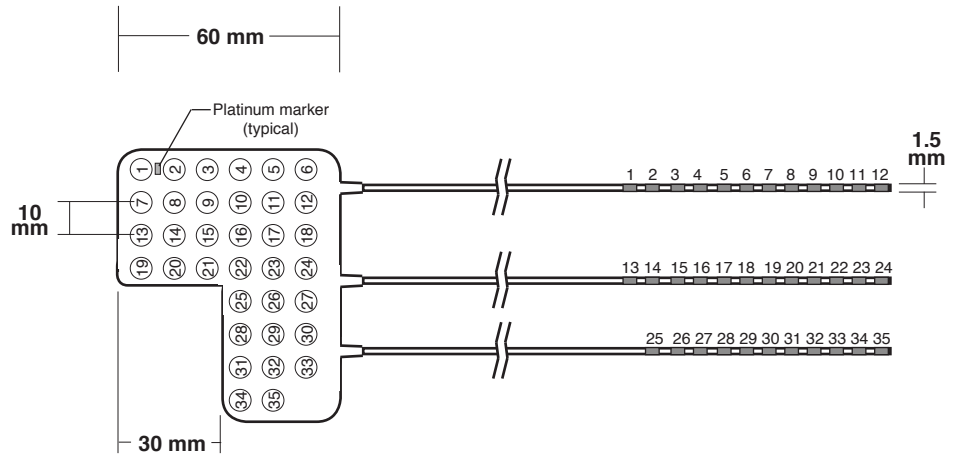

Electrodes are shown with the exposed contact surfaces facing DOWN.

Catalog #	Description	CABRIO Cable	TECH-ATTACH Components		
			Cable	Block	Qty
FG35D-SP10X-Z00	Right temporal lobe LTM grid	L-SRL-35DIN	L-DCL-35DIN	DC-11X & DC-12X	1 2
FG35E-SP10X-Z00	Left temporal lobe LTM grid	L-SRL-35DIN	L-DCL-35DIN	DC-11X & DC-12X	1 2

severn EPILEPSY/LTM SINGLE-TAIL SUBDURAL GRID ELECTRODES

- Numbered, **platinum** contacts, 4.0mm diameter with 2.3mm exposure.
- May be used with the single-tail passing needles.
- Single-tail construction reduces the number of tunnels.
- 60cm long tail.
- Sterile; single-use only.

Catalog #: IG20C-SP10X-0TB

20-contact, 4x5, single-tail LTM grid.
Platinum contacts.

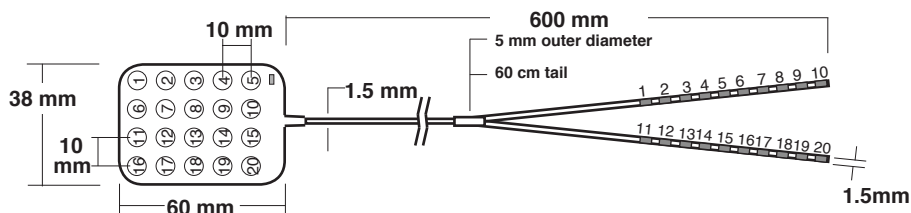

Catalog #: IG32C-SP10X-0TB

32-contact, 4x8, single-tail LTM grid.
Platinum contacts.

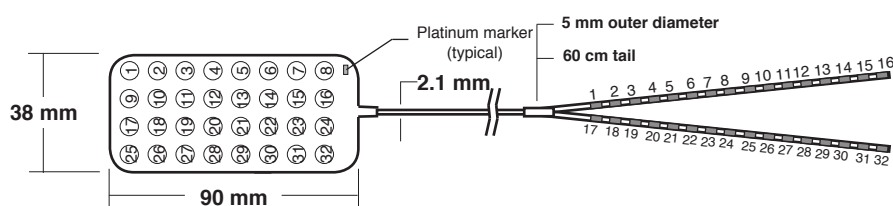

Catalog #: IG64C-SP10X-0TB

64-contact, 8x8, single-tail LTM grid.
Platinum contacts.

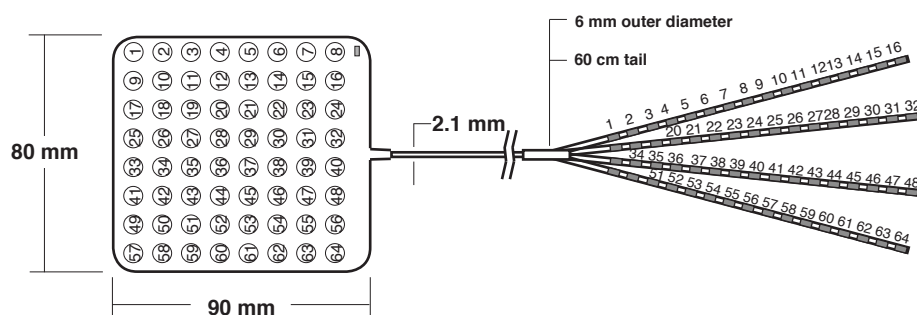

Electrodes are shown with the exposed contact surfaces facing DOWN.

Catalog #	Description	CABRIO Cable	TECH-ATTACH Components		
			Cable	Block	Qty
IG20C-SP10X-0TB	4x5 LTM grid	L-SRL-20DIN	L-DCL-20DIN	DC-10X	2
IG32C-SP10X-0TB	4x8 LTM grid	L-SRL-32BDIN	L-DCL-32BDIN	DC-16X	2
IG64C-SP10X-0TB	8x8 LTM grid	L-SRL-64BDIN	L-DCL-64BDIN	DC-16X	4

- Markers as shown for easy identification.
- Sterile; single-use only.
- **Platinum** contacts, 4.0mm diameter with 2.3mm exposure.
- Multi-strip and split-grid construction reduces the number of tunnels.
- May be used with the single-tail passing needles.

Catalog #: GG16A-SP10X-100

16-contact, 4x1x4, 2-tail.
Multi-strip LTM subdural electrode.
Platinum contacts.
41cm tail length.

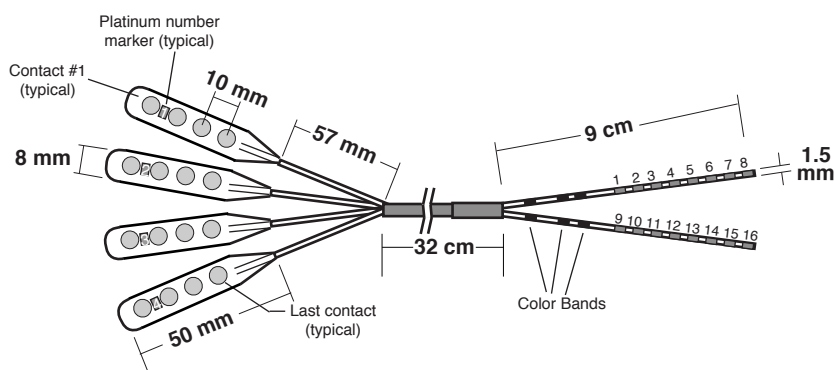

Catalog #: HG32A-SP05X-000

32-contact, 2x2x8, 2-tail.
Split-grid LTM subdural grid electrode.
Platinum contacts.
57cm tail length.

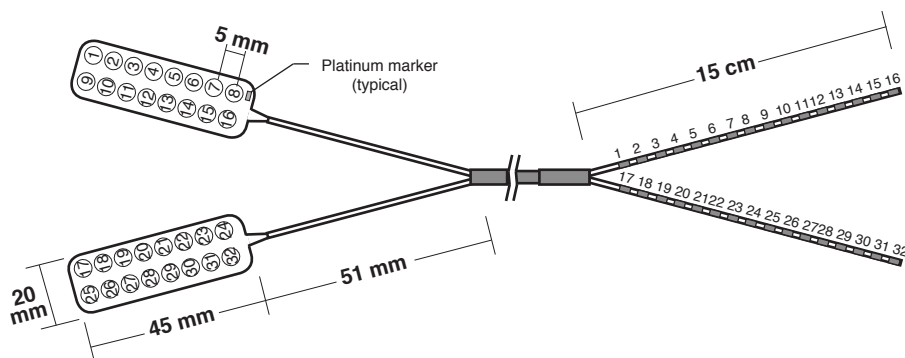

Electrodes are shown with the exposed contact surfaces facing DOWN.

Catalog #	Description	CABRIO Cable	TECH-ATTACH Components		
			Cable	Block	Qty
GG16A-SP10X-100	4x1x4, 2-tail multi-strip	L-SRL-16DIN	L-DCL-16DIN	DC-8X	2
HG32A-SP05X-000	2x2x8, 2-tail split-grid	L-SRL-32BDIN	L-DCL-32BDIN	DC-16X	2

severn  **EPILEPSY/LTM DUAL-SIDED INTERHEMISPHERIC
SUBDURAL ELECTRODES**

- Mirror-imaged contacts on both sides of the electrode.
- Platinum & number markers as shown.
- Sterile; single-use only.
- **Platinum** contacts, 4.0mm diameter with 2.3mm exposure.

Catalog #: DS08A-SP10X-000

8-contact, 1x4, dual-sided LTM strip.
Platinum contacts.

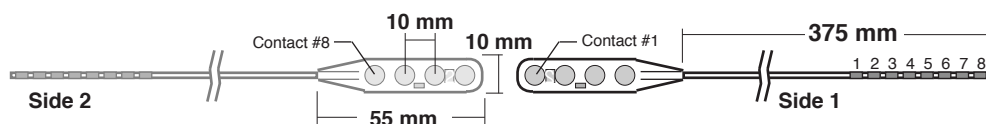

Catalog #: DS12A-SP10X-000

12-contact, 1x6, dual-sided LTM strip.
Platinum contacts.

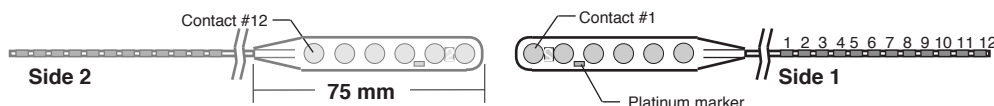

Catalog #: DG20A-SP10X-U00

20-contact, 2x5, angled, dual-sided LTM grid.
Platinum contacts.

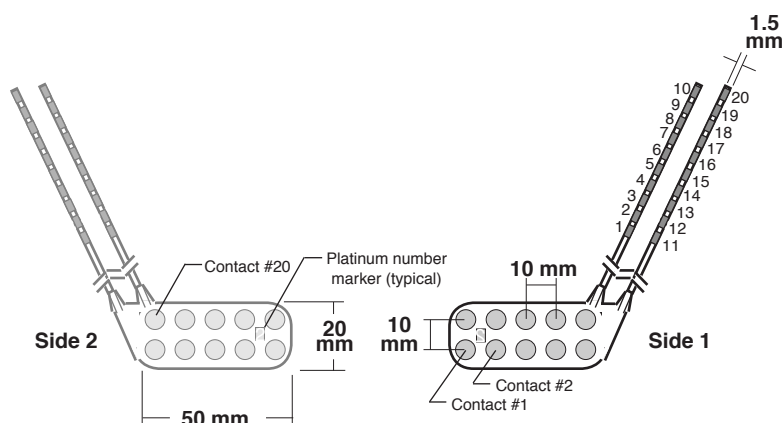

Catalog #: DG32A-SP10X-V00

32-contact, 2x8, curved, dual-sided LTM grid.
Platinum contacts.

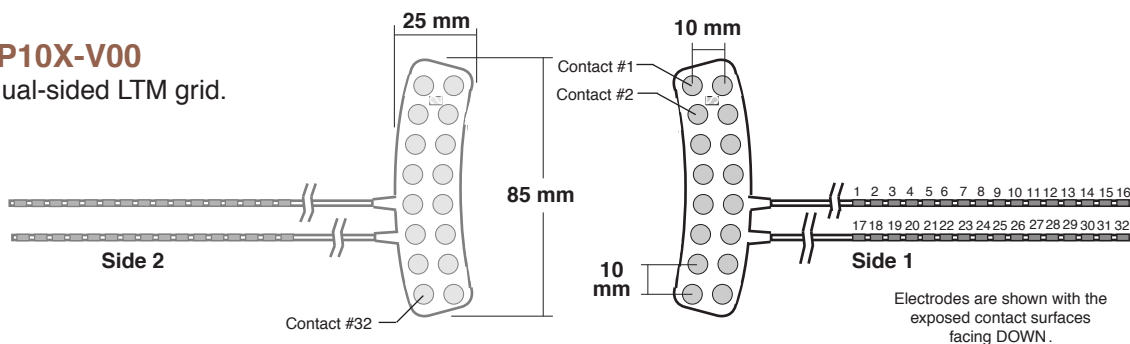

Catalog #	Description	CABRIO Cable	TECH-ATTACH Components		
			Cable	Block	Qty
DS08A-SP10X-000	1x4 dual strip	L-SRL-8DIN	L-DCL-8DIN	DC-8X	1
DS12A-SP10X-000	1x6 dual strip	L-SRL-12BDIN	L-DCL-12BDIN	DC-12X	1
DG20A-SP10X-U00	2x5 angled, dual grid	L-SRL-20DIN	L-DCL-20DIN	DC-10X	2
DG32A-SP10X-V00	2x8 curved, dual grid	L-SRL-32BDIN	L-DCL-32BDIN	DC-16X	2

severn IOM ELECTRODES WITH ATTACHED CABLES

- 6mm **platinum** indented contacts with 5mm exposure.
- Attached 1.8 meter cable.
- Sterile; single-use only.
- One-piece, easy to use.
- Includes random color code on body and tail.



Catalog #: FG08A-IP10X-0JH

8-contact, 2x4 large, 3D style IOM grid with attached 1.8m cable.

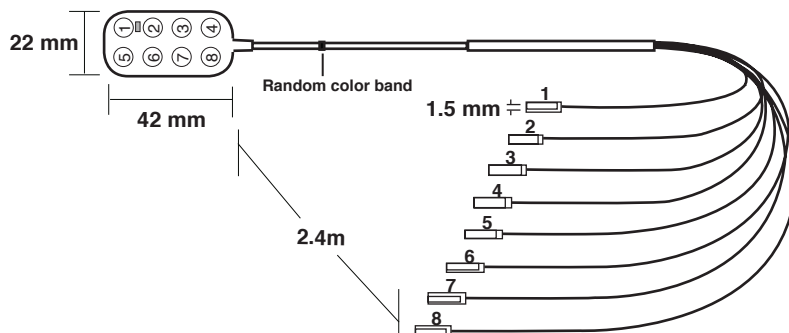

Catalog #: MS04R-IP10X-0JH

4-contact, 1x4 large, 3D style IOM strip with attached 1.8m cable.

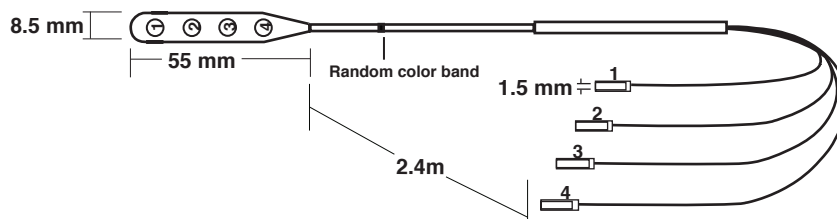

Catalog #: MS06R-IP10X-0JH

6-contact, 1x6 large, 3D style IOM strip with attached 1.8m cable.

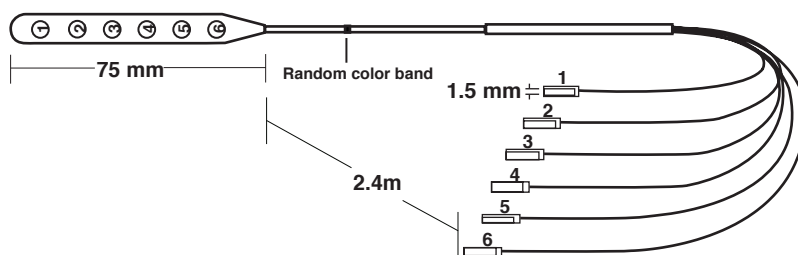

Catalog #: MS08R-IP10X-0JH

8-contact, 1x8 large, 3D style IOM strip with attached 1.8m cable.

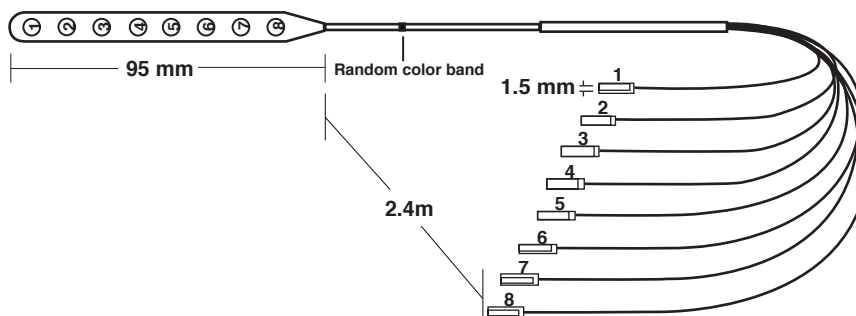

Electrodes are shown with the exposed contact surfaces facing DOWN.

Catalog #	Description
FG08A-IP10X-0JH	2x4 large, "3D" style grid with attached cable
MS04R-IP10X-0JH	1x4 large, "3D" style strip with attached cable
MS06R-IP10X-0JH	1x6 large, "3D" style strip with attached cable
MS08R-IP10X-0JH	1x8 large, "3D" style strip with attached cable

severn INTRAOPERATIVE MAPPING ELECTRODE SYSTEM

- The intraoperative mapping electrode system provides an alternative design for intraoperative monitoring.
- Clover-leaf electrode shape stabilizes the electrode contact on the brain.
- **Stainless steel** numbered contacts, 6.0mm diameter with 5.0mm exposure, 3D style.
- Sterile; single-use only.
- 1.5mm safety socket.

**Catalog #: VG04A-IS00X-0KH
& VG04A-IS00X-0KG**
4-contact numbered mapping electrode.
Stainless steel contacts.

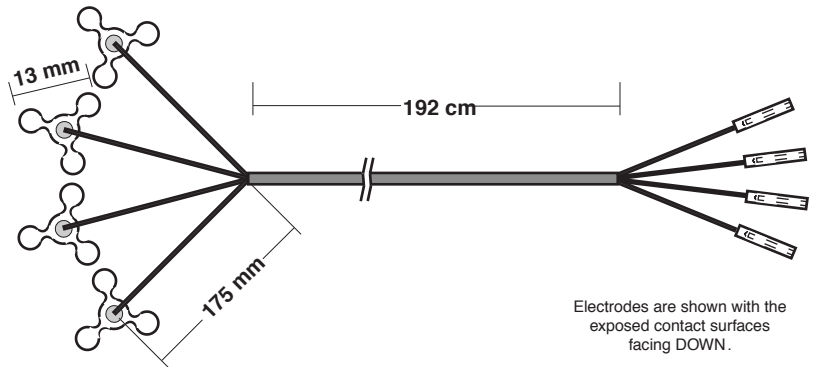

Catalog #	Description
VG04A-IS00X-0KG	Mapping electrode, numbered 1-4
VG04A-IS00X-0KH	Mapping electrode, numbered 5-8

AD-TECH® EPIDURAL SPINAL ELECTRODES

- For intraoperative monitoring of evoked potential (EPs) of the descending pathway during spinal surgery. D-Waves.
- 2 or 3 **platinum** contacts.
- Sterile; single-use only.
- Includes 16 gauge tuohy needle.
- Attached 1.2 meter cable.

Catalog #: CEDL-2PDINX-101
2-contact spinal electrode with pre-attached lead and stylet. Platinum contacts.

& CEDL-3PDINX-100
3-contact spinal electrode with pre-attached lead and stylet. Platinum contacts.

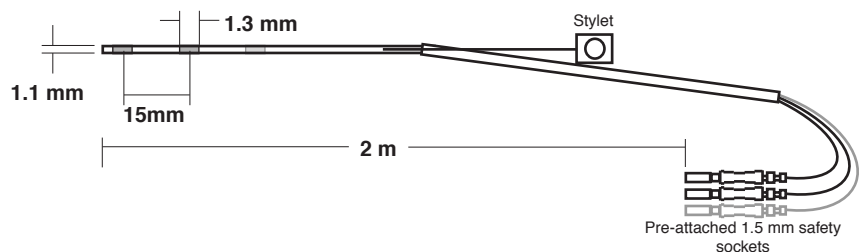

Catalog #	Description	Placement Qty
CEDL-2PDINX-101	2-contact spinal electrode	16 ga. Tuohy Needle + stylet
CEDL-3PDINX-100	3-contact spinal electrode	16 ga. Tuohy Needle + stylet

- For monitoring/mapping subsurface levels of the brain during the surgical treatment of epilepsy.
- **Platinum** contacts (Length: 2.41mm or 1.32mm).
- 1.12mm diameter.
- Contact spacing measured from center of contact to center of contact.
- Numbered and color coded for identification.
- 19cm marker.
- Includes stay flange for additional security.
- Sterile; single-use only.

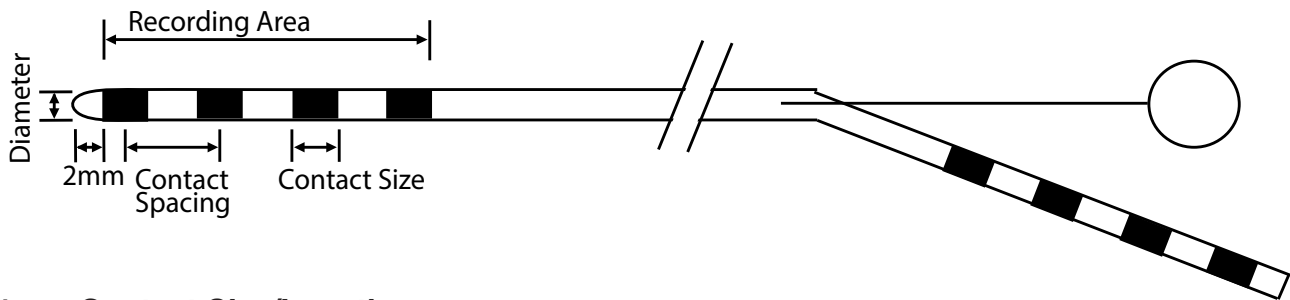

2.41mm Contact Size/Length

Part Number	# of Contacts	Contact Spacing	Recording Area	Overall Depth Length
SD04R-SP05X-000	4	5 mm	17 mm	360 mm
SD04R-SP10X-000	4	10 mm	32 mm	360 mm
SD06R-SP05X-000	6	5 mm	27 mm	370 mm
SD06R-SP10X-000	6	10 mm	52 mm	370 mm
SD08R-SP05X-000	8	5 mm	37 mm	380 mm
SD08R-SP10X-000	8	10 mm	72 mm	380 mm
SD10R-SP05X-000	10	5 mm	47 mm	390 mm
SD10R-SP10X-000	10	10 mm	92 mm	390 mm
SD12R-SP05X-000	12	5 mm	57 mm	400 mm

1.32mm Contact Size/Length

Part Number	# of Contacts	Contact Spacing	Recording Area	Overall Depth Length
SD04R-AP58X-000	4	2.2 mm	8 mm	360 mm
SD06R-AP58X-000	6	2.2 mm	12 mm	370 mm
SD08R-AP58X-000	8	2.2 mm	17 mm	380 mm

- Used with Neuronavigational devices to help with accurate placement of depth electrodes.
- **Platinum** 1.27mm long contacts.
- 1.96mm diameter.
- Contact spacing measured from center of contact to center of contact.
- Numbered and color coded for identification.
- Sterile; single-use only.

1.27mm Contact Size/Length

Part Number	# of Contacts	Contact Spacing	Recording Area	Overall Depth Length
AD04R-SP10X-000 *	4	10 mm	31 mm	360 mm
AD08R-SP05X-000 *	8	5 mm	36 mm	380 mm

- sEEG Depth for monitoring/mapping subsurface levels of the brain during the surgical treatment of epilepsy.
- **Platinum** contacts (Length: 2.29mm).
- 0.86mm diameter.
- Contact spacing measured from center of contact to center of contact.
- Numbered and color coded for identification, 19cm marker.
- Depths with up to 10 contacts has stylet.
- Sterile; single-use only.
- CE up to 10 contacts.
- Special order. Please contact Ad-Tech for availability.

2.29mm Contact Size/Length

Part Number	# of Contacts	Contact Spacing	Recording Area	Overall Depth Length
RD06R-SP05X-000	6	5 mm	27 mm	370 mm
RD08R-SP04X-000	8	4 mm	30 mm	380 mm
RD08R-SP05X-000	8	5 mm	37 mm	380 mm
RD10R-SP03X-000	10	3 mm	29 mm	390 mm
RD10R-SP04X-000	10	4 mm	38 mm	390 mm
RD10R-SP05X-000	10	5 mm	47 mm	390 mm
RD10R-SP06X-000	10	6 mm	56 mm	390 mm
RD10R-SP07X-000	10	7 mm	65 mm	390 mm
RD10R-SP08X-000	10	8 mm	74 mm	390 mm

* Not CE marked

severn  **EPILEPSY/LTM BEHNKE FRIED DEPTH ELECTRODES**

- For simultaneous macro and micro contact recordings.
- 8-contact macro recording outer body with 8 or 9-contact micro recording.
- **Platinum** contacts.
- Contact 1 starts 1.0 mm +/- 0.5 mm from body tip.
- Sterile; single-use only.

Catalog #: BF08R-SP05X-000
8-contact macro depth electrode.

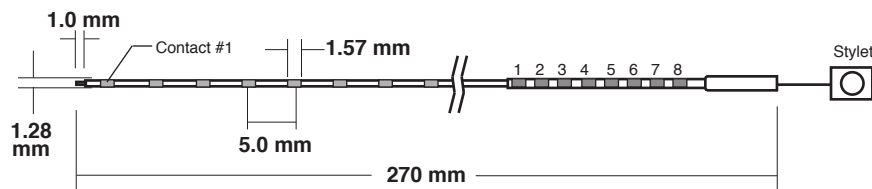

Catalog #: WB09R-SP00X-0B6
9-contact micro-wire bundle
(8 recording & 1 reference contact). Ends in "standard" pigtail.

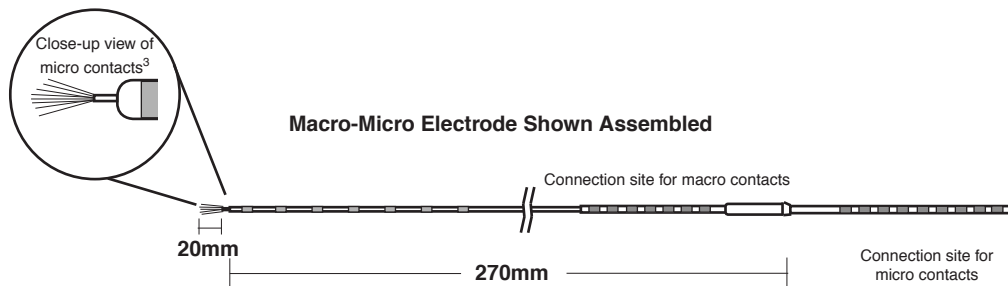
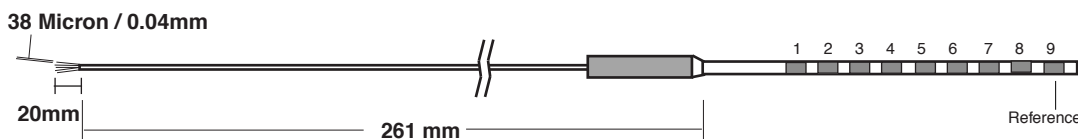

Catalog #	Description ¹	Contact Size ²	TECH-ATTACH Components		Cable
			Cable	Block	
BF08R-SP05X-000	8-contact macro depth	1.57/1.28	L-DCL-8DIN	Included	n/a
WB09R-SP00X-0B6	9-contact micro depth	0.04 dia.	n/a	n/a	L-SRL-9DIN

¹ Each electrode requires the TECH-ATTACH or wire bundle cable as indicated. A special, slotted connector block that connects the macro contacts to the TECH-ATTACH cable is included with each BF-series electrode.
² Overall length of the contact followed by its diameter (mm).
³ Micro wires extend 2 cm past the tip; trim to desired length prior to use.

severn  **EPILEPSY/LTM MACRO-MICRO DEPTH ELECTRODES**

- For simultaneous macro and micro recordings of the deep brain structures.
- Sterile; single-use only.
- **Platinum** contacts.
- 1.3 mm diameter.
- 80% Platinum, 20% Iridium HML insulator.
- 50.8 Platinum Micron Wire.
- One piece design.
- Allow 6-8 weeks for delivery (made to order).

Catalog #: MM16C-SP05X-000
 16-Contact Macro-Micro Depth.
 6 macro contacts, 10 micro wires cut flush. 5mm spacing between macros.

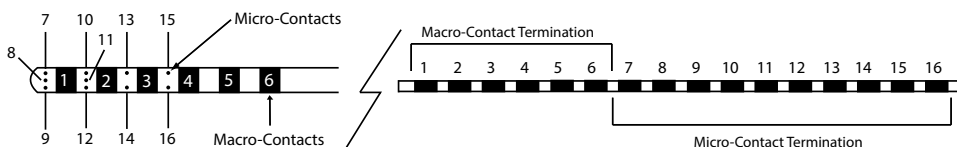

Catalog #: MM16D-SP05X-000
 16-Contact Macro-Micro Depth.
 8 macro contacts, 8 micro wires cut flush. 5mm spacing between macros.

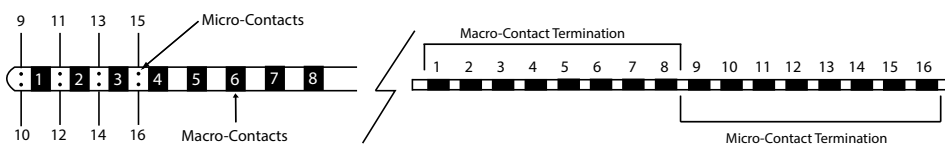

Catalog #	Description	# of Macro Contacts	# of Micro Contacts
MM16C-SP05X-000	16-contact macro-micro depth	6	10
MM16D-SP05X-000	16-contact macro-micro depth	8	8

Many cable options are available for the micro recording tails.

Contact your Ad-Tech representative to discuss these options.

severn EPILEPSY/LTM FORAMEN OVALE ELECTRODES

- One piece body construction.
- 1.02 mm body diameter.
- Each set includes two foramen ovale electrodes, two 17 gauge (0.04 inch/1.016mm) introducing needles for placement, and two TECH-ATTACH connector blocks.
- Each set requires cable indicated.
- Uses FO-style TECH-ATTACH connection systems.
- 2.41 mm long, **platinum** contacts.
- Sterile; single-use only.

Catalog #: FO04K-SP05X-000

4-contact FO set, 5mm spacing.

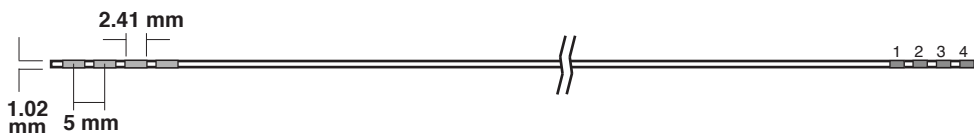

Catalog #: FO06K-SP10X-000

6-contact FO set, 10mm spacing.

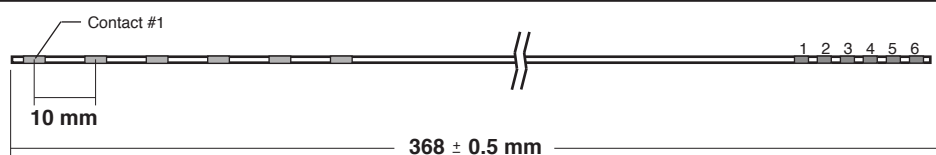

Catalog #	Description ¹	TECH-ATTACH Components	
		Cable	Block
FO04K-SP05X-000	4-contact FO set	FO-LDC-4DIN	Included
FO06K-SP10X-000	6-contact FO set	FO-LDC-6DIN	Included

AD-TECH[®] DEPTH ELECTRODE ANCHOR BOLTS

- For placement of depth electrodes with stereotactic or frameless systems.
- Sterile; single-use only.
- Titanium body (MRI friendly).
- Individually packaged, 3 per box.

Catalog #: LSBK1-AX-05

2.5mm distal opening diameter. 21mm long.
Use with SD style depth electrodes.

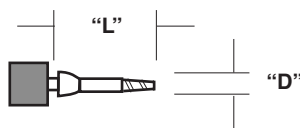

Catalog #: LSBK2-AX-04

.99mm distal opening diameter. 21mm long.
Gold Anodized.
Use with RD style depth electrodes.

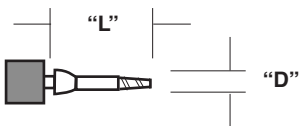

Catalog #	Description	Distal Opening Diameter "D"	Length "L"	Units
LSBK1-AX-05	Use with SD depth electrodes	2.5 mm	21 mm	3 Per Box
LSBK1-AX-06	Use with BF, LD or MM depth electrodes	2.5 mm	21 mm	3 Per Box
LSBK1-BX-05	Use with SD depth electrodes	2.5 mm	13 mm	3 Per Box
LSBK1-BX-06	Use with BF, LD or MM depth electrodes	2.5 mm	13 mm	3 Per Box
LSBK2-AX-04	Use with RD depth electrodes	0.99 mm	21 mm	3 Per Box
LSBK2-BX-04	Use with RD depth electrodes	0.99 mm	13 mm	3 Per Box

RD = Blue gasket
SD = Green gasket
LD/BF/MM = Clear gasket

LEKSELL FRAME
PASSING NEEDLE

CATALOG #	DESCRIPTION
LK-GB-N-13	Stainless Steel Drill Sleeve Blocks. <i>Non-Sterile, Re-Usable.</i>
SCSG-90-2.18N	Stainless Steel Slotted Cannula Guide. <i>Non-Sterile, Re-Usable.</i>
2SCK1-190X	Two-Piece Slotted Cannula - 190mm (2.11 diameter) 2/Box <i>Sterile, Re-Usable.</i>
2SCK1-240X	Two-Piece Slotted Cannula - 240mm (2.11 diameter) 2/Box <i>Sterile, Re-Usable.</i>
RULER-20N	20cm Channeled Ruler for drill stop & depth electrode measurement. <i>Non-Sterile, Re-Usable.</i>

ANCHOR BOLTS

CATALOG #	DESCRIPTION
LK-GB-N-13	Stainless Steel Drill Sleeve Blocks. <i>Non-Sterile, Re-Usable.</i>
DSG-90-2.3N	Guide for Drill & Placement/Removal Wrench (2.4mm diameter). <i>Non-Sterile, Re-Usable.</i>
SCSG-90-2.18N	Stainless Steel Slotted Cannula Guide. <i>Non-Sterile, Re-Usable.</i>
DDK2-2.4-30X	2.4mm Drill Kit; (2) 30cm drill with stop and (1) wrench. <i>Sterile, Single-Use Only.</i>
LSB-PWL-2.4-10X	Placement/Removal Wrench for LSB series (24.5cm). <i>Non-Sterile, Re-Usable.</i>
OB-20-190X	Obturator, used to make track inside brain - used with RD style anchor bolts. <i>Sterile, Single-Use Only.</i>
RULER-20N	20cm Channeled Ruler for drill stop & depth electrode measurement. <i>Non-Sterile, Re-Usable.</i>

Pictures of products on page 27

CRW FRAME
PASSING NEEDLE

CATALOG #	DESCRIPTION
SCSG-90-2.18N	Stainless Steel Slotted Cannula Guide. <i>Non-Sterile, Re-Usable.</i>
2SCK1-190X	Two-Piece Slotted Cannula - 190mm (2.11 diameter) 2/Box <i>Sterile, Re-Usable.</i>
2SCK1-240X	Two-Piece Slotted Cannula - 240mm (2.11 diameter) 2/Box <i>Sterile, Re-Usable.</i>
RULER-20N	20cm Channeled Ruler for drill stop & depth electrode measurement. <i>Non-Sterile, Re-Usable.</i>

ANCHOR BOLTS

CATALOG #	DESCRIPTION
DSG-90-2.3N	Guide for Drill & Placement/Removal Wrench (2.4mm diameter). <i>Non-Sterile, Re-Usable.</i>
SCSG-90-2.18N	Stainless Steel Slotted Cannula Guide. <i>Non-Sterile, Re-Usable.</i>
DDK2-2.4-30X	2.4mm Drill Kit; (2) 30cm drill with stop and (1) wrench. <i>Sterile, Single-Use Only.</i>
LSB-PWL-2.4-10X	Placement/Removal Wrench for LSB series (24.5cm). <i>Non-Sterile, Re-Usable.</i>
OB-20-190X	Obturator, used to make track inside brain - used with RD style anchor bolts. <i>Sterile, Single-Use Only.</i>
RULER-20N	20cm Channeled Ruler for drill stop & depth electrode measurement. <i>Non-Sterile, Re-Usable.</i>

Pictures of products on page 27

• Leksell Stereotactic System® & StealthStation® are registered trademarks of Elekta & Medtronic/Sofamor-Danek respectively. CRW™ and NaviVision™ are trademarks of Radionics & BrainLab.

BRAIN LAB
PASSING NEEDLE

CATALOG #	DESCRIPTION
BLNG-2X	Guide Tube to Fit BrainLab Neuronavigation system, used with slotted cannulas. <i>Sterile, Re-Usable.</i>
2SCK1-190X	Two-Piece Slotted Cannula - 190mm (2.11 diameter) 2/Box <i>Sterile, Re-Usable.</i>
2SCK1-240X	Two-Piece Slotted Cannula - 240mm (2.11 diameter) 2/Box <i>Sterile, Re-Usable.</i>
RULER-20N	20cm Channeled Ruler for drill stop & depth electrode measurement. <i>Non-Sterile, Re-Usable.</i>

ANCHOR BOLTS

CATALOG #	DESCRIPTION
DSG-90-2.3N	Stainless Steel Drill (2.4mm drill) Sleeve/Placement Wrench Guide. <i>Non-Sterile, Re-Usable.</i>
DDK2-2.4-30X	2.4mm Drill Kit; (2) 30cm drill with stop and (1) wrench. <i>Sterile, Single-Use Only.</i>
LSB-PWL-2.4-10X	Placement/Removal Wrench for LSB series (24.5cm). <i>Non-Sterile, Re-Usable.</i>
OB-20-190X	Obturator, used to make track inside brain - used with RD style anchor bolts. <i>Sterile, Single-Use Only.</i>
RULER-20N	20cm Channeled Ruler for drill stop & depth electrode measurement. <i>Non-Sterile, Re-Usable.</i>

Pictures of products on page 27

MEDTRONIC STEALTH
PASSING NEEDLE

CATALOG #	DESCRIPTION
SNG-AX	Guide Tube to Fit Stealth Neuronavigation system, used with slotted cannulas. <i>Sterile, Re-Usable.</i>
2SCK1-190X	Two-Piece Slotted Cannula - 190mm (2.11 diameter) 2/Box <i>Sterile, Re-Usable.</i>
2SCK1-240X	Two-Piece Slotted Cannula - 240mm (2.11 diameter) 2/Box <i>Sterile, Re-Usable.</i>
RULER-20N	20cm Channeled Ruler for drill stop & depth electrode measurement. <i>Non-Sterile, Re-Usable.</i>











ANCHOR BOLTS

CATALOG #	DESCRIPTION
DDK2-2.4-30X	2.4mm Drill Kit; (2) 30cm drill with stop and (1) wrench. <i>Sterile, Single-Use Only.</i>
LSB-PWL-2.4-10X	Placement/Removal Wrench for LSB series (24.5cm). <i>Non-Sterile, Re-Usable.</i>
OB-20-190X	Obturator, used to make track inside brain - used with RD style anchor bolts. <i>Sterile, Single-Use Only.</i>
RULER-20N	20cm Channeled Ruler for drill stop & depth electrode measurement. <i>Non-Sterile, Re-Usable.</i>

Pictures of products on page 27

• Leksell Stereotactic System® & StealthStation® are registered trademarks of Elekta & Medtronic/Sofamor-Danek respectively. CRW™ and NaviVision™ are trademarks of Radionics & BrainLab.

PLACEMENT ACCESSORY PRODUCT DRAWINGS

CATALOG #	PART	
LK-GB-N-13	<i>Guide Blocks</i> <ul style="list-style-type: none"> • Leksell Frame • Non-Sterile 	
SCSG-90-2.18N	<i>Slotted Cannula Guide</i> <ul style="list-style-type: none"> • Non-Sterile 	For use with: RD & SD style depths 
SCSG2-90-2.18N	<i>Slotted Cannula Guide</i> <ul style="list-style-type: none"> • Non-Sterile 	For use with: BF & MM style depths 
2SCK1-240X 2SCK1-190X	<i>Slotted Cannula</i> <ul style="list-style-type: none"> • Sterile 	For use with:  RD & SD style depths
RULER-20N	<i>Ruler</i> <ul style="list-style-type: none"> • Non-Sterile 	
DSG-90-2.3N	<i>Drill Sleeve Guide</i> <ul style="list-style-type: none"> • For 2.4mm Drill • Non-Sterile 	For use with: RD, SD, & 1 tail MM style depths 
DDK2-2.4-30X	<i>Drill Kit</i> <ul style="list-style-type: none"> • Sterile 	
OB-20-190X	<i>Obturator</i> <ul style="list-style-type: none"> • Sterile 	
LSB-PWL-2.4-10X	<i>Anchor Bolt Placement/Removal Wrench</i> <ul style="list-style-type: none"> • Non-Sterile 	For use with: LSB Bolts Series 
SNG-AX	<i>Medtronic Depth Guide Tube</i> <ul style="list-style-type: none"> • Sterile 	For use with: RD & SD style depths 

• **RD:** Reduced diameter depth (0.86mm diameter)
 • **SD:** Standard depth (1.1mm diameter)
 • **MM:** Macro-Micro depth (1.3mm diameter)

severn DISPOSABLE DRILL KITS

- Each kit includes two drills, two drill stops, and one adjustment wrench.
- For drilling cranial holes using a stereotactic frame.
- Stainless steel construction.
- 30cm or 16cm long.
- Sterile; single-use only.

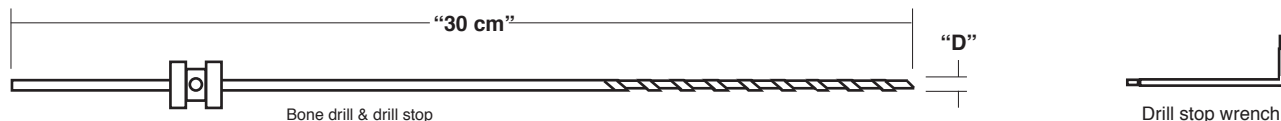

Catalog #	Description	Diameter "D"	Units
DDK2-2.4-30X	Use with LSB bolts, 30cm long	2.4 mm	2 Per Box
DDK2-2.8-30X	Use with BAB and DGL bolts	2.8 mm	2 Per Box
DDK2-2.4-16X	Use with LSB bolts, 16 cm long	2.4 mm	2 Per Box

AD-TECH® PASSING NEEDLES

- For tunneling the electrode wire carriers or "tails" away from the surgical site.
- Individually packaged.
- Sterile; single-use only.

Catalog #: APNK1-3.5X

Passing needle. 2.4mm diameter. 3.5 inch length. (5/Box).



Catalog #: LPNK1-10X

Single-tail passing needle. 6.4mm diameter. 10 inch length. (For use with single-tail electrode dividing into 3 or more tails). (2/Box).

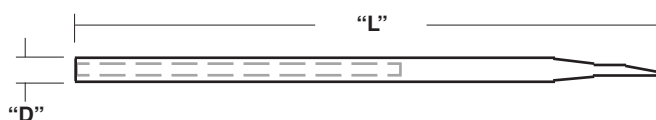

Catalog #: BPNK1-10X

Bent single-tail passing needle. 6.4mm diameter. 10 inch length. (For use with single-tail electrode dividing into 3 or more tails). (2/Box)

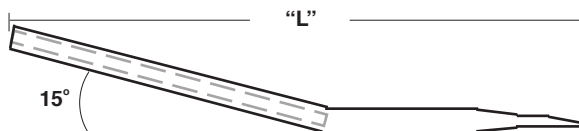

& BPNK2-10X

Bent single-tail passing needle. 5.1mm diameter. 10.25 inch length. (For use with single tail electrodes dividing into 2 tails). (2/Box)

Catalog #	Description	Diameter "D"	Length "L"	Units
APNK1-3.5X	Passing needle	13 ga. (2.4mm)	3.5 in (8.9 cm)	5 Per Box
LPNK1-10X	Single-tail passing needle	0.25 in (6.4mm)	10 in (25.4 cm)	2 Per Box
BPNK1-10X	Bent single-tail passing needle	0.25 in (6.4mm)	10 in (25.4 cm)	2 Per Box
BPNK2-10X	Bent single-tail passing needle	0.20 in (5.1mm)	10.25 in (26 cm)	2 Per Box

■ LPNK1-10X and BPNK1-10X are for 3 or more tails. BPNK2-10X are for 2 tails.

- Lightweight & flexible.
- 1.8 meter (6 feet) length - additional cable lengths available.
- Quick disconnect option available.

Lightweight CABRIO Connection System

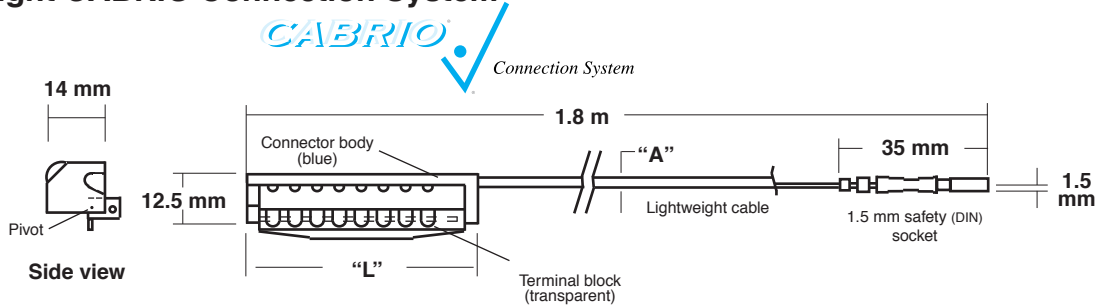

Catalog #	Description	Terminal Configuration	Dimension "L"	Cable Diameter "A"
L-SRL-4DIN	4-contact lightweight CABRIO connector/cable	1 terminal of 4	34 mm	2.21 mm
L-SRL-6DIN	6-contact lightweight CABRIO connector/cable	1 terminal of 6	44 mm	2.67 mm
L-SRL-8DIN	8-contact lightweight CABRIO connector/cable	1 terminal of 8	54 mm	2.67 mm
L-SRL-9DIN	9-contact lightweight CABRIO connector/cable	1 terminal of 9	64 mm	3.23 mm
L-SRL-10DIN	10-contact lightweight CABRIO connector/cable	1 terminal of 10	64 mm	3.23 mm
L-SRL-12BDIN	12-contact lightweight CABRIO connector/cable	1 terminal of 12	94 mm	3.76 mm
L-SRL-16BDIN	16-contact lightweight CABRIO connector/cable	1 terminal of 16	94 mm	3.76 mm
L-SRL-20DIN	20-contact lightweight CABRIO connector/cable	2 terminals of 10	64 mm	2 x 3.23 mm
L-SRL-32BDIN	32-contact lightweight CABRIO connector/cable	2 terminals of 16	94 mm	2 x 3.76 mm
L-SRL-48BDIN	48-contact lightweight CABRIO connector/cable	3 terminals of 16	94 mm	3 x 3.76 mm
L-SRL-64BDIN	64-contact lightweight CABRIO connector/cable	4 terminals of 16	94 mm	4 x 3.76 mm

Lightweight TECH-ATTACH Connection System

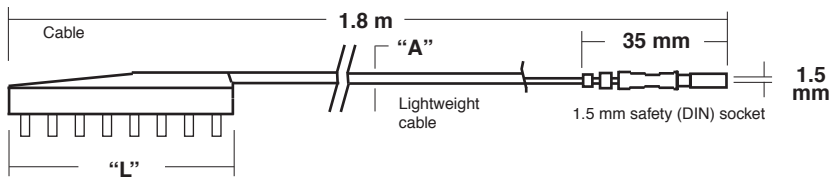

Catalog #	Description	Terminal Configuration	Dimension "L"	Cable Diameter "A"
L-DCL-4DIN	4-contact lightweight TECH-ATTACH cable	1 terminal of 4	34 mm	2.21 mm
L-DCL-6DIN	6-contact lightweight TECH-ATTACH cable	1 terminal of 6	44 mm	2.67 mm
L-DCL-8DIN	8-contact lightweight TECH-ATTACH cable	1 terminal of 8	54 mm	2.67 mm
L-DCL-9DIN	9-contact lightweight TECH-ATTACH cable	1 terminal of 9	64 mm	3.23 mm
L-DCL-10DIN	10-contact lightweight TECH-ATTACH cable	1 terminal of 10	64 mm	3.23 mm
L-DCL-12BDIN	12-contact lightweight TECH-ATTACH cable	1 terminal of 12	94 mm	3.76 mm
L-DCL-16BDIN	16-contact lightweight TECH-ATTACH cable	1 terminal of 16	94 mm	3.76 mm
L-DCL-20DIN	20-contact lightweight TECH-ATTACH cable	2 terminals of 10	64 mm	2 x 3.23 mm
L-DCL-32BDIN	32-contact lightweight TECH-ATTACH cable	2 terminals of 16	94 mm	2 x 3.76 mm
L-DCL-48BDIN	48-contact lightweight TECH-ATTACH cable	3 terminals of 16	94 mm	3 x 3.76 mm
L-DCL-64BDIN	64-contact lightweight TECH-ATTACH cable	4 terminals of 16	94 mm	4 x 3.76 mm

■ Lightweight CABRIO and TECH-ATTACH cables are supplied with 1.5 mm safety sockets. Where not prohibited by law, alternative termination options are available upon request. Non-sterile; sterilize via ETO (EO) or Sterrad. All lightweight TECH-ATTACH cables require the use of disposable connector blocks.

severn LIGHTWEIGHT QUICK DISCONNECT CABLES

- ODU Connector allowing for quick disconnect of the cable.
- Great for OR Monitoring.
- Please allow 10-12 days for delivery (made to order).
- Contact Ad-Tech to inquire about additional available lengths.

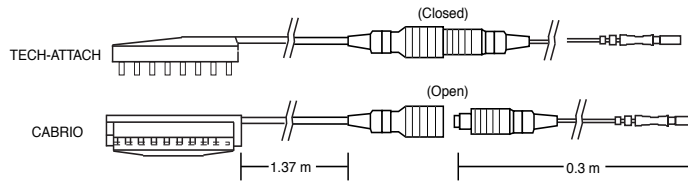

Catalog #	Description	Terminal Configuration	Dimension "L"	Cable Diameter "A"
L-SRL-4DIN-10	4-contact lightweight CABRIO connector/cable	1 terminal of 4	34 mm	2.21 mm
L-SRL-6DIN-10	6-contact lightweight CABRIO connector/cable	1 terminal of 6	44 mm	2.67 mm
L-SRL-8DIN-10	8-contact lightweight CABRIO connector/cable	1 terminal of 8	54 mm	2.67 mm
L-SRL-10DIN-10	10-contact lightweight CABRIO connector/cable	1 terminal of 10	64 mm	3.23 mm
L-SRL-12BDIN-10	12-contact lightweight CABRIO connector/cable	1 terminal of 12	94 mm	3.76 mm
L-SRL-16BDIN-10	16-contact lightweight CABRIO connector/cable	1 terminal of 16	94 mm	3.76 mm
L-SRL-20DIN-10	20-contact lightweight CABRIO connector/cable	2 terminals of 10	64 mm	2 x 3.23 mm
L-SRL-32BDIN-10	32-contact lightweight CABRIO connector/cable	2 terminals of 16	94 mm	2 x 3.76 mm
L-SRL-48BDIN-10	48-contact lightweight CABRIO connector/cable	3 terminals of 16	94 mm	3 x 3.76 mm
L-SRL-64BDIN-10	64-contact lightweight CABRIO connector/cable	4 terminals of 16	94 mm	4 x 3.76 mm
L-DCL-4DIN-10	4-contact lightweight TECH-ATTACH cable	1 terminal of 4	34 mm	2.21 mm
L-DCL-6DIN-10	6-contact lightweight TECH-ATTACH cable	1 terminal of 6	44 mm	2.67 mm
L-DCL-8DIN-10	8-contact lightweight TECH-ATTACH cable	1 terminal of 8	54 mm	2.67 mm
L-DCL-10DIN-10	10-contact lightweight TECH-ATTACH cable	1 terminal of 10	64 mm	3.23 mm
L-DCL-12DIN-10	12-contact lightweight TECH-ATTACH cable	2 terminals of 6	66 mm	3.76 mm
L-DCL-16BDIN-10	16-contact lightweight TECH-ATTACH cable	1 terminal of 16	94 mm	3.76 mm
L-DCL-20DIN-10	20-contact lightweight TECH-ATTACH cable	2 terminals of 10	64 mm	2 x 3.23 mm
L-DCL-24DIN-10	24-contact lightweight TECH-ATTACH cable	3 terminals of 8	94 mm	2 x 3.76 mm
L-DCL-32BDIN-10	32-contact lightweight TECH-ATTACH cable	2 terminals of 16	94 mm	3 x 3.76 mm
L-DCL-48BDIN-10	48-contact lightweight TECH-ATTACH cable	3 terminals of 16	94 mm	3 x 3.76 mm
L-DCL-64BDIN-10	64-contact lightweight TECH-ATTACH cable	4 terminals of 16	94 mm	4 x 3.76 mm

AD-TECH® DISPOSABLE CONNECTOR BLOCKS

TECH-ATTACH Disposable Connector Blocks

(Box of 10). Sterile.

■ All TECH-ATTACH connector blocks are packaged in sets of two with five sets per box. Sold by box of ten only. Sterile; single-use only.

Catalog #	Description	Used with Lightweight TECH-ATTACH Cable
DC-2X	2-contact block	L-DCL-2DIN
DC-3X	3-contact block	L-DCL-3DIN
DC-4X	4-contact block	L-DCL-4DIN
DC-5X	5-contact block	L-DCL-5DIN
DC-6X	6-contact block	L-DCL-6DIN
DC-8X	8-contact block	L-DCL-8DIN, -16DIN, -32DIN, -48DIN, -64DIN
DC-10X	10-contact block	L-DCL-10DIN, -20DIN, -40BDIN
DC-11X	11-contact block	L-DCL-35DIN
DC-12X	12-contact block	L-DCL-12BDIN, -24BDIN, -35DIN & -48DDIN
DC-16X	16-contact block	L-DCL-16BDIN, -32BDIN, -48BDIN & -64BDIN

severn  **DISPOSABLE BRAIN BIOPSY NEEDLES**

- Supplied as complete kits (needle stop & aspirator tube with Luer lock; 10 cm models also include a barium sleeve).
- Available in standard lengths: 10 cm, 19 cm & 24 cm (custom lengths available).
- Inner and outer cannula have polished, rounded closed ends.
- 14 gauge (0.083 inch/ 2.11 mm) diameter.
- Nominal 8 mm side cutting window.
- Also available in MR-conditional materials.
- 304 stainless steel with 1 cm markings.
- High quality & low cost.
- For stereotactic-guided procedures.
- Sterile; single-use only.

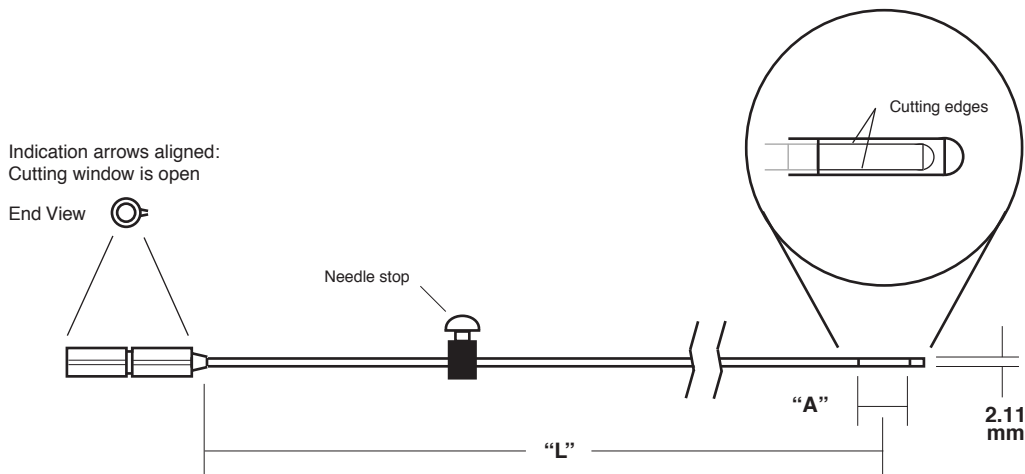

*Most Common catalog number
"A" = 8mm

Catalog #	Description	Dimension "L"	Units
DBN-08-10X	Biopsy needle	10 cm	1 Per Box
DBN-08-19X	Biopsy needle	19 cm	1 Per Box
DBN-08-24X	Biopsy needle	24 cm	1 Per Box
MDBN-08-28X	MR-Conditional biopsy needle	28 cm	1 Per Box

severn  **CUEVA INTRAOPERATIVE CRANIAL NERVE ELECTRODES**

- For direct cranial nerve monitoring during skull base surgeries.
- Circumferential design, 2.0 mm or 3.0 diameter “C-Shaped” electrode.
- Supplied in complete sterile kits. Each kit includes two 2.0 mm or 3.0 mm cranial electrodes, two 25 cm long applicator wands, and two 6 foot (1.8 m) lead wires terminating in a 1.5 mm safety socket.
- All lead wires interface with standard EEG/EP amplifiers using 1.5 mm safety sockets.
- Platinum contacts.
- Easy-to-use applicator, 250 mm long.
- Highly-consistent amplitude; real-time status.
- Sterile; single-use only.
- **Not CE Marked.**

MISCELLANEOUS PRODUCTS

Catalog #: CNE1-2KDINX

2mm cranial nerve electrode kit.

& CNE1-3KDINX

3mm cranial nerve electrode kit.

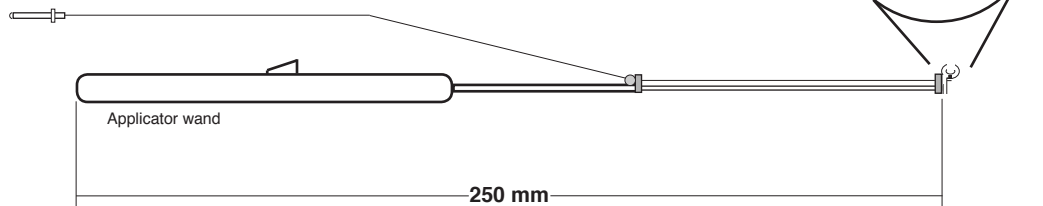

Cranial nerve electrode lead wire
(EEG interface cable)

Catalog #	Description	Units
CNE1-2KDINX	2mm cranial nerve electrode kit	2 Per Box
CNE1-3KDINX	3mm cranial nerve electrode kit	2 Per Box

- Lightweight & disposable.
- Two different 0.55 mm diameter tip styles (dull & sharp).
- Bent distal portion of all tips is approximately 5 mm long.
- Sterile; single-use only.
- Individually packaged.
- Ad-Tech's Subpial Transectors are not CE marked.

Catalog #: MST-D03X

Pre-attached dull tip. (3/Box).

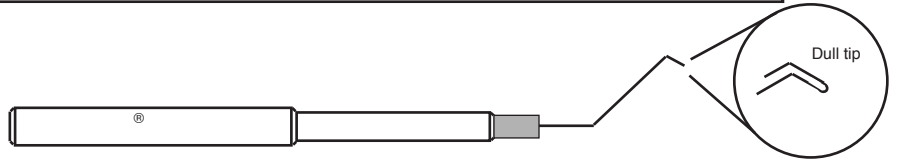

Catalog #: MST-S03X

Pre-attached sharp tip. (3/Box).

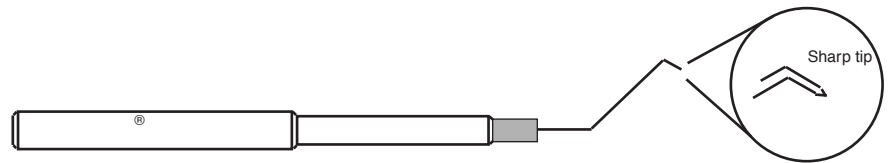

Catalog #	Description ¹
MST-D03X	MST handle with pre-attached dull tip. Box of three individually sterilized units
MST-S03X	MST handle with pre-attached sharp tip. Box of three individually sterilized units

AD-TECH® EPILEPSY/LTM SPHENOIDAL ELECTRODES

- Supplied as kits (2 electrodes, 2 introducing needles, & 2 lead wires).
- Two needle lengths available - 2.0 inches (51 mm) & 2.75 inches (70 mm) long.
- 0.011 inch (0.28 mm) **stainless steel** or 0.007 inch (0.18 mm) **platinum** wire, 30 cm in length; un-insulated 3-4 mm tip.
- 21 gauge (0.033 inch/0.84 mm) needle; other introducing needles available upon request.
- Sterile; single-use only.

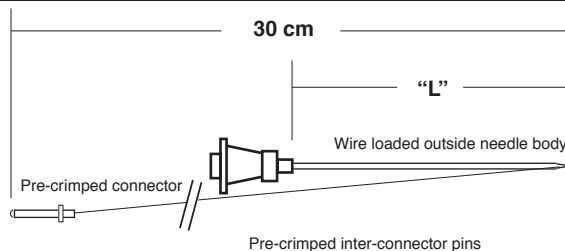

Catalog #	Description ¹	Inter-Connector Pin Style	Wire Location	Wire Diameter	Needle Length Dimension "L"
711-1DINX-01	Sphenoidal electrode kit	pre-crimped	outside needle	0.011 in (0.28 mm)	2.75 in (70 mm)
711-1DINX-05	Sphenoidal electrode kit	pre-crimped	outside needle	0.011 in (0.28 mm)	2.00 in (51 mm)
711-1PDINX-01	Sphenoidal electrode kit	pre-crimped	outside needle	0.007 in (0.18 mm)	2.75 in (70 mm)
711-1PDINX-05	Sphenoidal electrode kit	pre-crimped	outside needle	0.007 in (0.18 mm)	2.00 in (51 mm)

NOTES:

ITEMS REGULARLY ORDERED:

POLICIES

CONTACT INFORMATION: To contact Ad-Tech, please call, fax, or e-mail us at the addresses found at the bottom of the page. To email orders, please email: customersupport@adtechmedical.com.

ORDERING INFORMATION: Ad-Tech accepts the following forms of payment:

- American Express, MasterCard or Visa
- Wire Transfers
- ACH

SHIPPING INFORMATION: Ad-Tech will ship your order using UPS or FEDEX. Shipping/Handling charges depend on the dimensional weight, value and destination of the item(s). Shipping is FOB Ad-Tech and is prepaid and added to the invoice. Other shipping methods or carriers may be available.

PRICING VALIDITY: Prices are valid through June 2014, although prices are subject to change without notice.

TERMS & CONDITIONS: Payment terms are Net 30 Days. Unpaid balances are subject to a 1.5% per month finance charge.

STANDARD POLICIES: The purchaser agrees to comply with Ad-Tech's standard policies pertaining to Returned Goods, Product Traceability, Medical Device Reporting and Customer Complaints, as well as with all applicable Laws & Restrictions of the USA Export Administration and of the purchaser's country. Contact Ad-Tech for additional information.

RESTOCKING: All returns for credit are subject to a restocking charge. Contact Ad-Tech prior to returning any product.

RETURNED GOODS: A Return Authorization Number is required prior to returning product to Ad-Tech. Unauthorized shipments without an RMA number may not be accepted. Contact Ad-Tech for details.

PURCHASER'S/END-USER'S REMEDIES: The Purchaser's/End-User's sole and exclusive remedy shall be the replacement of the product by Ad-Tech, free of charge. Contact Ad-Tech for additional warranty information.

LATEX STATEMENT: Ad-Tech's products are not manufactured with natural rubber latex.

CE MARKINGS: Please contact Ad-Tech for a complete list of CE Marked products.

SPECIFICATIONS: All specifications and claims are subject to change without notice.

ASSISTANCE: Assistance from Ad-Tech is available 24 hours a day, 365 days per year.



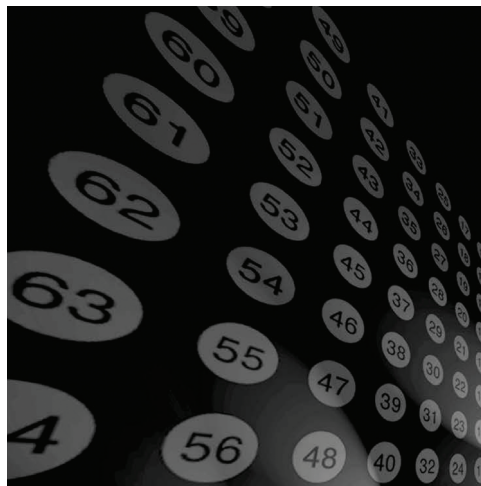

Severn Healthcare Technologies Limited
38 Kingfisher Court, Hambridge Road
Newbury, Berkshire RG14 5SJ
Telephone: 01635 887640 Fax: 01635 41227
Email: service@severnhealthcare.com

severnhealthcare.com

VOLUME VII